



DAG1000-4S VoIP Gateway User Manual V3.0



Dinstar Technologies Co., Ltd.

Address: 9th Floor, Guoxing Building, Changxing Road, Nanshan District, Shenzhen, China

Postal Code: 518052

Telephone: +86 755 61919966

Fax: +86 755 2645 6659

Emails: sales@dinstar.com, support@dinstar.com

Website: www.dinstar.com

Revision Record

File Name	DAG1000-4S VoIP Gateway User Manual
Document Version	V3.0
Firmware Version	2.19.01.07
Date	2016/04/19
Revised by	Technical Support Department

Preface

Welcome

Thanks for choosing **DAG1000-4S VoIP Gateway**! We hope you will make optimum use of this flexible, rich-feature VoIP-to-FXS gateway. Please read this document carefully before install the gateway.

About this manual

This manual provides information about the introduction of the gateway, and about how to install, configure or use the gateway.

For interoperability with different IPPBX/Softswitch platform, you can refer to relevant configuration guide of different systems.

This manual is written with reference to the default configurations of the **DAG1000-4S** VoIP Gateway.

Intended audience

This manual is aimed primarily at network and system engineers who will install, configure and maintain the gateway.

System engineers are persons who customize the configurations to meet the requirements of users.

Parts of the document containing description of telephony features are aimed at users who are the persons who will actually use the gateway.

Contents

1 Introduction of DAG1000-4S	1
1.1 Overview	1
1.2 Equipment Appearance.....	2
1.3 Ports and Connectors.....	2
1.4 Functions and Features	3
1.4.1 Protocol standard supported	3
1.4.2 Voice and Fax parameters.....	3
1.4.3 Supplementary service.....	4
2 Basic Operations	5
2.1 Methods to Number Dialing.....	5
2.2 Direct IP Calls.....	5
2.3 Call Holding.....	6
2.4 Call Waiting	6
2.5 Call Transfer.....	6
2.5.1 Blind Transfer	6
2.5.2 Attended Transfer	6
2.6 Three-way Calling.....	7
2.7 Description of Feature Codes.....	7
2.8 Sending and Receiving Fax	9
2.8.1 T. 38 and Pass-Through	9
2.9 Local IVR Operation.....	9
2.9.1 Inquire IP address.....	9
2.9.2 Factory Reset.....	9
2.9.3 Configure LAN Port's IP Address	9
3 Configurations on Web Interface	11
3.1 Network Connection	11
3.2 Preparations for Login.....	11
3.3 Log in Web Interface	12
3.4 Navigation Tree	13
3.5 State and Statistics	14

3.5.1 System Information.....	14
3.5.2 Registration Information.....	16
3.5.3 TCP/UDP Statistics.....	17
3.5.4 RTP Session Statistics.....	17
3.5.5 CDR Statistics.....	17
3.6 Quick Setup Wizard.....	18
3.7 Network Configuration.....	18
3.7.1 Local Network.....	18
3.7.2 VLAN (Virtual Local Area Network).....	20
3.7.3 DHCP Server (Route Mode).....	22
3.7.4 DMZ Host (Route Mode).....	23
3.7.5 Forward Rule (Route Mode).....	23
3.7.6 Static Route (Route Mode).....	24
3.7.7 ARP.....	24
3.8 SIP Server.....	25
3.9 Port.....	28
3.10 Advanced.....	30
3.10.1 FXS/FXO Parameters.....	30
3.10.2 Media Parameter.....	32
3.10.3 SIP Parameters.....	34
3.10.4 Fax Parameter.....	39
3.10.5 Digit Map.....	40
3.10.6 Feature Codes.....	41
3.10.7 System Parameter.....	42
3.10.8 Action URL.....	44
3.11 Call & Routing.....	45
3.11.1 Wildcard Group.....	45
3.11.2 Port Group.....	45
3.11.3 IP Trunk.....	47
3.11.4 Routing Parameter.....	48
3.11.5 IP -> Tel Routing.....	49
3.11.6 Tel-IP/Tel Routing.....	50
3.11.7 IP – IP Routing.....	51

3.12 Manipulation Configuration	51
3.12.1 IP -> Tel Callee	52
3.12.2 Tel -> IP/Tel Caller	53
3.12.3 Tel-IP/Tel Callee.....	54
3.13 Routing rule examples.....	54
3.13.1 Route any calls from any IP to specific port	54
3.13.2 Route any calls from any IP to specified port group	55
3.13.3 Route any calls from any port to specific SIP IP trunk.....	56
3.14 Maintenance	58
3.14.1 TR069.....	58
3.14.2 SNMP	58
3.14.3 Syslog.....	60
3.14.4 Provision.....	62
3.14.5 Cloud server	63
3.15 Security.....	63
3.15.1 WEB ACL	63
3.15.2 Telnet ACL	64
3.15.3 Passwords.....	64
3.16 Tools	65
3.16.1 Firmware upload	65
3.16.2 Data Backup	67
3.16.3 Data Restore.....	67
3.16.4 Ping Test	67
3.16.5 Tracert Test	68
3.16.6 Outward Test.....	69
3.16.7 Network Capture	70
3.16.8 Factory Reset.....	74
3.16.9 Device Restart	74
4 Glossary	75

1 Introduction of DAG1000-4S

1.1 Overview

DAG1000-4S VoIP gateway provides voice services based on IP network. It's a cost-effective and flexible solution for SOHO (Small Office-Home office), remote office, medium-sized enterprise and enterprise with multiple branches.

The gateway connects to analog telephone, fax and traditional analog PBX with standard voice interfaces and provides high quality voice service.

The gateway, based on standard SIP protocol is compatible with leading IP PBX, soft-switch and SIP-based platform.

The FXS analog gateway available in the following configurations:

Model	Voice Channels	FXS Ports	Physical Port Labels
DAG1000-4S	4	4	0-3

For detailed hardware and software features, please refer to "product specifications".

1.2 Application Scenario

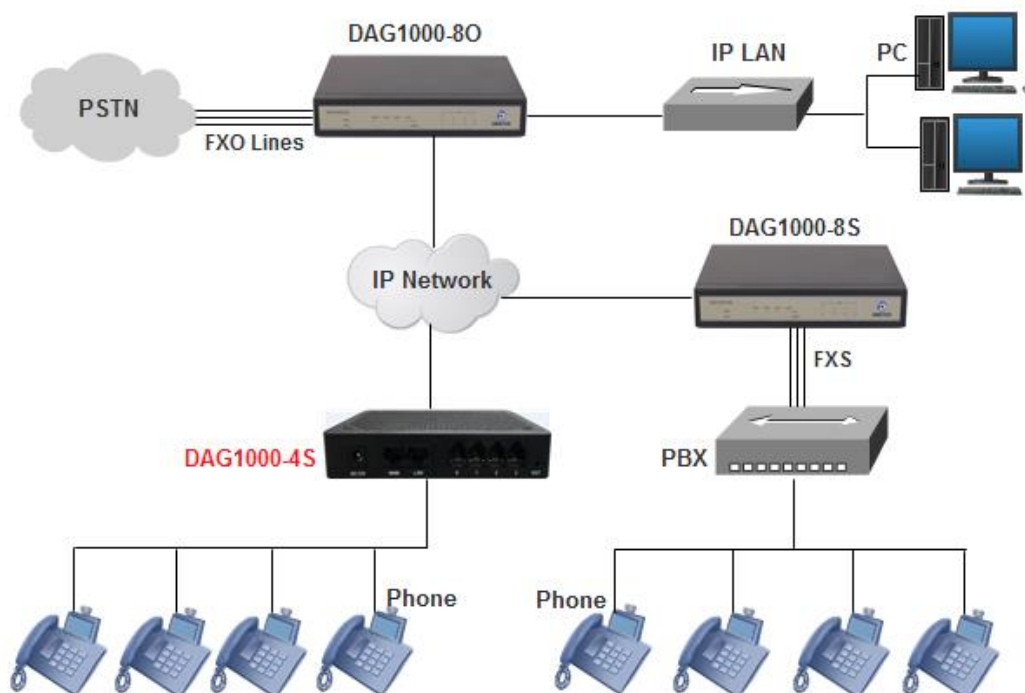

1.3 Equipment Appearance



Front View



Back View

1.4 Ports and Connectors

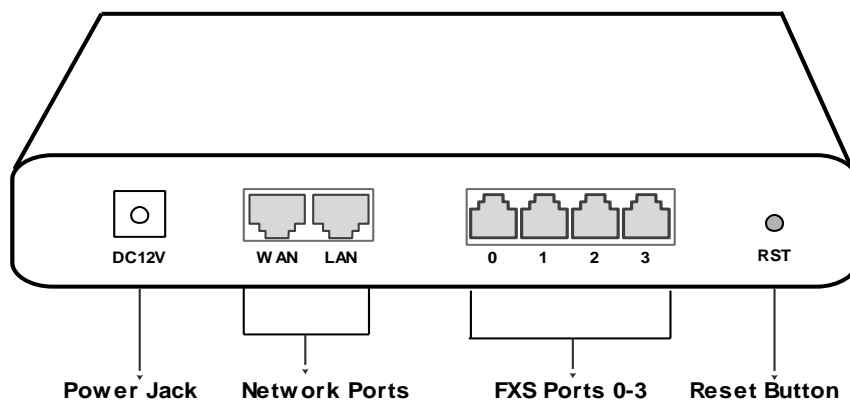
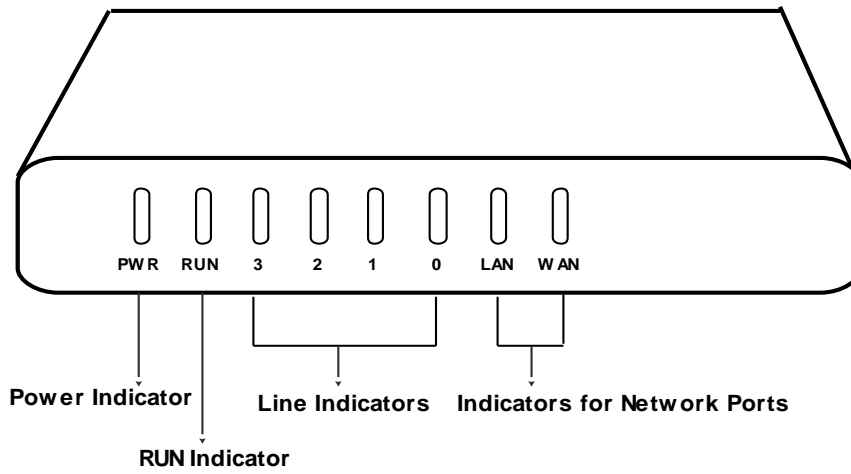

Port Name	Connector	Description
Power Jack	Power Jack	To connect DC 12V power supply
WAN/LAN Port	RJ45	to connect to the IP network over a DSL modem or Router or a LAN switch
FXS Ports 0-3	RJ11	FXS ports to connect standard analog phone or FAX machine or a PBX

1.5 Functions and Features

1.5.1 Protocol standard supported

- SIP V2.0 (RFC 3261,3262,3264)
- SDP (RFC 2327)
- REFER (RFC 3515)
- RTP/RTCP (RFC 1889,1890)
- STUN (RFC 3489)
- ARP/RARP (RFC 826/903)
- SNTP (RFC 2030)
- DHCP/PPPoE
- TFTP/HTTP/HTTPS
- DNS/DNS SRV (RFC 1706/RFC 2782)
- VLAN 802.1P/802.1Q

1.5.2 Voice and Fax parameters

- G.711A/U law, G.723.1, G.729AB,iLBC,AMR
- Comfortable Noise Generation (CNG)
- Voice Activity Detection (VAD)

- Echo Cancellation (G.168)
- Adaptive Dynamic Jitter Buffer
- Voice and fax gain control
- Modem
- T.38/Pass-through
- DTMF Mode: Signal/RFC2833/INBAND

1.5.3 Supplementary service

- Call waiting
- Call transfer (Blind transfer, Attend transfer,)
- Quick pick
- Call Forwarding Unconditional
- Call Forwarding on No Reply
- Hotline
- Call hold
- DND
- Three-way conference
- Voice mail
- Direct IP Call

2 Basic Operations

2.1 Methods to Number Dialing

Dial mobile phone or extension number

- ▶ Dial the number directly and wait for 3 seconds (Default “No dial timeout”);
- ▶ Dial the number directly and press #.

2.2 Direct IP Calls

The DAG1000-4S gateway allows users to directly call through IP address. Under this circumstance, the user only needs an analog phone which is connected to a FXS port of the gateway, and calls can be established without register.

Calls can be established through IP address as long as one of the following conditions is met.

- ▶ Both the DAG1000-4S and other VoIP device have public IP addresses;
- ▶ The DAG1000-4S and other VoIP device use private IP addresses of a same LAN;
- ▶ The DAG1000-4S and other VoIP device can be connected through a router and use public or private IP addresses (with necessary port forwarding or DMZ).

Operation Process:

Step1: Pick up the analog phone and then dial “*47”;

Step2: Enter the target IP address.

【Note】 : No dial tone will be played between step 1 and step 2

Example:

Assume that the target IP address is 192.168.0.160, user need to dial *47 and then **192*168*0*160**. After that, press the “#” key or wait 3 seconds. Then signaling interaction is completed and ringing can be heard .

【Note】 :You cannot make direct IP calls between FXS0 to FXS1 of a same DAG1000-4S since they are using same IP addresses. Call through IP address is only routed to the default destination port 5060.

2.3 Call Holding

Place a call on hold by pressing the “flash” button on the analog phone (if the phone has the button). Press the “flash” button again to release the previously held caller and resume conversation. If no “flash” button is available, use “hook flash” instead.

2.4 Call Waiting

If a calling party places a call to a called party which is otherwise engaged, and the called party has the call waiting feature enabled, the calling party will hear a IVR voice ‘Please hold on, the subscriber you dialed is busy’ and the called party will hear three beeps.

By pressing the flash button or the flash hook, the called party is able to switch between the new incoming call and the current call.

2.5 Call Transfer

2.5.1 Blind Transfer

Blind transfer is used to transfer call to a third party without informing the caller. Assume that A and B are in a conversation. A wants to blind Transfer B to C:

- ▶ A presses **FLASH** on the analog phone to hear the dial tone;
- ▶ Then A dials *87 and C’s number and # (or wait for 4 seconds);
- ▶ A will hear the confirm tone. Then, A hangs up, and B and C enter into a conversation.

Note:

“*Call features enable*” must be set to “Yes” on WEB configuration page. Caller A can place a call on hold and wait for one of the three situations:

- ▶ A quick confirmation tone (similar to call waiting tone) which follows the dial tone. This indicates the transfer is successful. At this point, Caller A can either hand up or make another call.
- ▶ A quick busy tone which follows a restored call (on supported platforms only). This means the transferee has received a 4xx response for the INVITE and we will try to recover the call. The busy tone indicates the transfer has failed.
- ▶ Continuous busy tone. This means the call has timed out.

2.5.2 Attended Transfer

Attended transfer allows the transferring party either connects the call to a ringing phone (ringback heard) or speaks with the third party before transferring the call to the third party.

Assume that A and B are in conversation. Caller A wants to *attended transfer* B to C:

- ▶ A presses **FLASH** on the analog phone and wait for dial tone;
- ▶ Then dial C's number followed by # (or wait for 3 seconds);
- ▶ If C answers the call, A and C are in conversation. Then A can hang up to complete the transfer;
- ▶ If C does not answer the call, A can press "flash" to resume call with B.

2.6 Three-way Calling

Three-way calling:

- ▶ A calls B, B picks up the phone, then A and B enters into conversation;
- ▶ A presses the hook flash, and the call between A and B is placed on hold. Then C calls A and A answers the call.
- ▶ A presses hook flash again, then the calls between A and B and between A and C are placed on hold.

At this time, if A presses 1 , conversation between A and B is resumed; if A presses 2, conversation between A and C is resumed; if A presses 3, A,B and C enter into conversation.

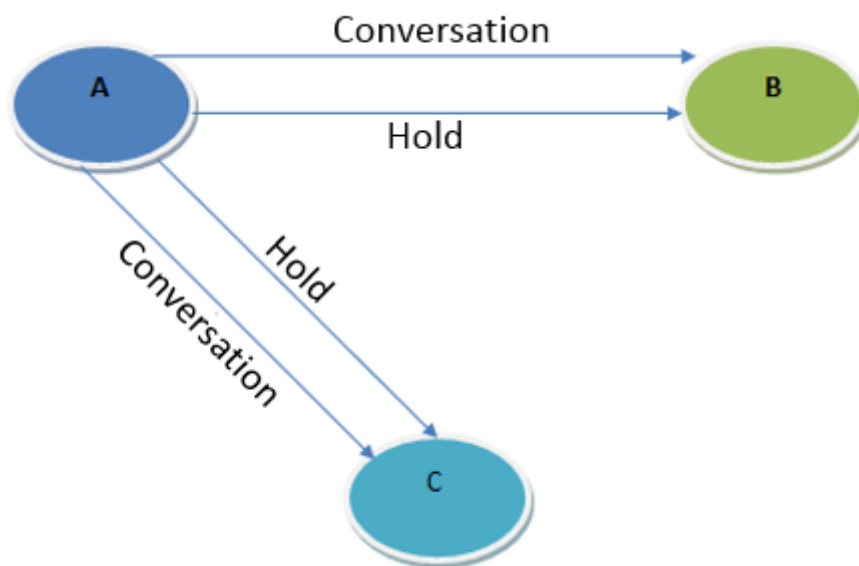

2.7 Description of Feature Codes

The DAG1000-4S gateway supports all traditional and senior phone function. It provides feature codes for easy maintenance and easy entry to phone functions.

Feature Codes	Corresponding Function
*158#	Dial *158# to inquiry the IP address of LAN port
*159#	Dial *159# to inquiry the IP address of WAN port

*114#	Dial *114# to inquire port account
150	Dial *150* to set the way of obtaining IP address
157	Dial *157*0 to set route mode; dial *157*1 to set bride mode
152	Dial *152* to set IPv4 address
153	Dial *153* to set subnet mask
156	Dial *156* to set default gateway's IP address
*193#	Dial *193# to renew the IP address
*160*1#	Dial *160*1# to open WAN port to visit web
*166*000000#	Dial *166*000000# to reset to factory defaults
*111#	Dial *111# to restart the gateway
*#	Dial *# to place a call on hold
47	Dial *47* to establish a call through IP address
*51#	Dial *51# to enable 'call waiting' feature
*50#	Dial *50# to disable 'call waiting' feature
87	Dial *87* to blind transfer a call
72	Dial *72* to enable 'unconditional call forwarding' feature
*73#	Dial *73# to disable 'unconditional call forward' feature
90	Dial *90* to enable 'busy call forwarding' feature
*91#	Dial *91# to disable 'busy call forwarding' feature
92	Dial *92* to enable 'no answer call forwarding' feature
*93#	Dial *93# to disable 'no answer call forwarding' feature
*78#	Dial *78# to enable DND
*79#	Dial *79# to disable DND
*200#	Dial *200# to access voice mail
Flash/Hook	Used to switch between incoming calls. If the phone is not in session, flash/hook will switch a new channel for a new call.

2.8 Sending and Receiving Fax

The DAG1000-4S gateway supports four fax modes:

- ▶ T.38 (FoIP)
- ▶ Pass-Through
- ▶ Modem
- ▶ Adaptive

2.8.1 T. 38 and Pass-Through

T.38 is the preferred fax mode because it is more reliable and works well in most network conditions. If the service provider supports T.38, please use this method by selecting T.38 as fax mode (default). If the service provider does not support T.38, pass-through mode may be used. If you have problems with sending or receiving Fax, toggle the Fax Tone Detection Mode setting.

2.9 Local IVR Operation

2.9.1 Inquire IP address

Connect analog phone to FXS ports of the DAG1000-4S gateway, then pick up the phone. After dialing tone, dial *158# to inquire the IP address of LAN port and dial *159# to inquire the IP address of WAN port.

2.9.2 Factory Reset

Pick up the phone, and then dial *166*000000#. After hearing a voice prompt of 'setting successfully', hang up the phone and the gateway is reset to factory defaults.

2.9.3 Configure LAN Port's IP Address

Before configuration, please ensure:

- ▶ The gateway is power on;
- ▶ Device has been connected to network;
- ▶ Telephone is connected to FXS port of the DAG1000-4S gateway.

Configure dynamic IP address by DHCP:

Pick up the phone, dial *150*2# and then hang up the phone.

If the voice prompt indicates 'setting successfully', please restart the gateway after 10 seconds.

Configure Static IP address:

Take the configuration of IP address '172.16.0.100' as example.

Pick up the phone, dial *150*1# and then hang up the phone.

Then configure IP address and mask as follow:

- Configure IP address

Pick up the phone, dial *152*172*16*0*100# and then hang up the phone.

- Configure subnet mask

Pick up the phone, dial *153*255*255*0*0# and then hang up the phone.

- Configure gateway IP address

Pick up the phone, dial *156*172*16*0*1# and then hang up the phone.

- Query the IP address of the DAG1000-4S gateway:

Pick up the phone, dial *158#.

If the gateway uses PPPoE method to get IP address, the IP address needs to be configured through web browser.

【Note】 : The telephone will play voice prompt "setting successfully" if the step is correct.

3 Configurations on Web Interface

3.1 Network Connection

DAG1000-4S works in two modes: route mode and bridge mode. When it is under the route mode, the IP of WAN port must be different from the IP of LAN port. But when it is under the bridge mode, the IP of WAN and the IP of LAN are the same.

Under the route mode, the default IP address of WAN port is a DHCP IP address, while the default IP address of the LAN port is 192.168.11.1.

Under the bridge mode, both the default IP addresses of the WAN port and the LAN port are 192.168.11.1.

Connect the DAG1000-4S gateway to the network according to the following network topology, and dial *158 to query the IP address of the gateway.

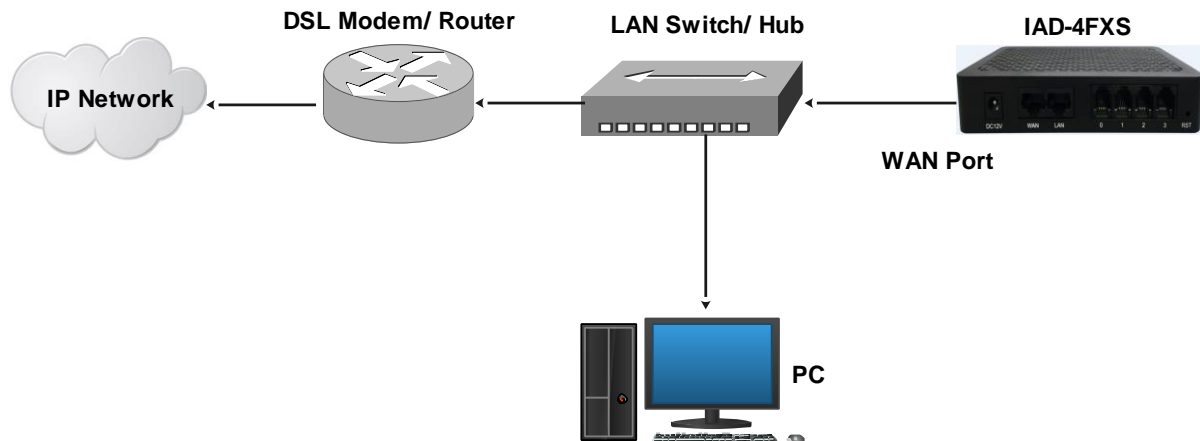

3.2 Preparations for Login

Modify the IP address of the PC to make it at the same network segment with the DAG1000-4S device, since the default IP address of the gateway is 192.168.11.1.

Take Windows 7 as an example, the IP address of PC is changed into 192.168.11.10:

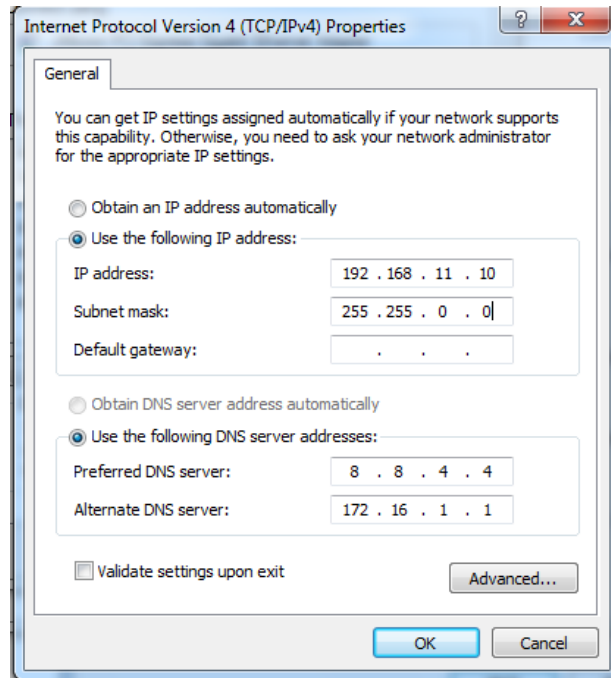

Check the connectivity between the PC and the gateway. Click **Start** → **Run** of PC and enter cmd to execute 'ping 192.168.11.1' to check whether the IP address of the DAG1000-4S gateway runs normally.

3.3 Log in Web Interface

Open a web browser and enter the IP address of the LAN port of the DAG1000-4S (the default IP of LAN port is 192.168.11.1, while that of WAN port is obtained via DHCP by default). Then the login GUI will be displayed. Both the default username and password are admin.

It is advised to modify the username and password for security consideration.

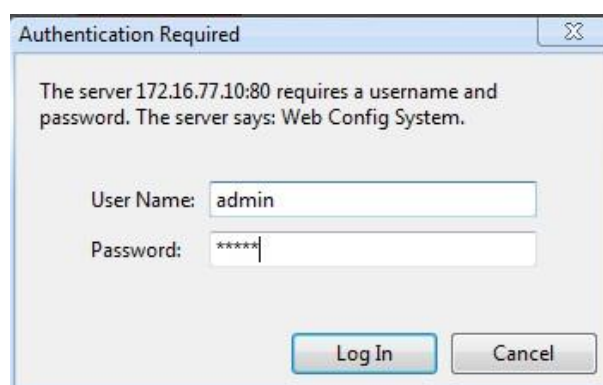

Enter default username and password: admin/admin, then click "Log in" to enter into the Web interface.

The screenshot displays the 'Web Management System' interface for a Dinstar device. On the left is a navigation tree with categories like Status & Statistics, Quick Setup Wizard, Network, SIP Server, Port, Advanced, Call & Routing, Manipulation, Management, Security, and Tools. The main content area shows 'System Information' with the following details:

Device ID	da00-0050-0600-0559		
MAC Address	00-01-97-56-69-B0		
Network Mode	Router		
WAN IP Address	172.16.118.205	255.255.0.0	Static
	172.16.1.1		
LAN Port	192.168.11.1	255.255.255.0	
DNS Server	8.8.8.8	4.4.4.4	
Cloud Register Status	Not Registered		
System Uptime	1h: 19m: 04s		
NTP Status	Succeed		
NTP Time	2016-4-19 02:09:44		
WAN Traffic Stat.	Received 42004351 bytes	Sent 281596 bytes	
Usage of Flash	84 %(10280960 / 12189956) bytes		
Usage of RAM in Linux	38 %(49221632 / 128884032) bytes		
Usage of RAM in AOS	12 %(4280320 / 33546240) bytes		
Current Software Version	DAG1000-4S 2.19.01.07 PCB 4 LOGIC 0 BIOS 1, 2016-03-10 16:33:10		
Backup Software Version	DAG1000-4S 1.19.01.07 PCB 4 LOGIC 0 BIOS 1, 2016-03-10 16:34:04		
DSP Version	MIPS_1_7 Nov 30 2015 17:18:14		
U-BOOT Version	5		
Kernel Version	4		
FS Version	3.0.14		
Hint Language	English		

3.4 Navigation Tree

The web management system of the DAG1000-4S VoIP gateway consists of the navigation tree and detailed configuration interfaces.

Choose a node of the navigation tree to enter into a detailed configuration interface.

The screenshot shows a vertical navigation tree with the following items:

- Status & Statistics
 - System Information
 - Registration
 - TCP/UDP Traffic
 - RTP Session
 - CDR
- Quick Setup Wizard
- + Network
- SIP Server
- Port
- + Advanced
- + Call & Routing
- + Manipulation
- + Management
- + Security
- + Tools

Note: When the gateway works under the bridge mode, configuration items including "Routing Configuration", "DHCP Service", "DMZ Host", "Forward Rules" and "Static Routing" and "ARP" will not be displayed.

3.5 State and Statistics

3.5.1 System Information

On the System Information interface, you can view the information of device ID, MAC address, network mode, IP addresses, version information, sever register status and so on.

System Information			
Device ID	da00-0050-0600-0559		
MAC Address	00-01-97-56-69-B0		
Network Mode	Router		
WAN IP Address	172.16.118.205	255.255.0.0	Static
	172.16.1.1		
LAN Port	192.168.11.1	255.255.255.0	
DNS Server	8.8.8.8	4.4.4.4	
Cloud Register Status	Not Registered		
System Uptime	1h: 19m: 04s		
NTP Status	Succeed		
NTP Time	2016-4-19 02:12:10		
WAN Traffic Stat.	Received 42004351 bytes	Sent 281596 bytes	
Usage of Flash	84 %(10280960 / 12189696) bytes		
Usage of RAM in Linux	38 %(49221632 / 128684032) bytes		
Usage of RAM in AOS	12 %(4280320 / 33546240) bytes		
Current Software Version	DAG1000-4S 2.19.01.07 PCB 4 LOGIC 0 BIOS 1, 2016-03-10 16:33:10		
Backup Software Version	DAG1000-4S 1.19.01.07 PCB 4 LOGIC 0 BIOS 1, 2016-03-10 16:34:04		
DSP Version	MIPS_1_7 Nov 30 2015 17:18:14		
U-BOOT Version	5		
Kernel Version	4		
FS Version	3.0.14		
Hint Language	English		

Figure 3.5-1 System Information

Explanation of items on System Information interface

Device ID	A unique ID of each device. This ID is used for warranty and cloud server authentication.
MAC address	Hardware address of the WAN port
Network Mode	Network modes include bridge and router. Under the Bridge mode , the network port will work as a small LAN switch. Under the Router Mode , NAT feature will be enabled under this mode.
WAN IP Address	<p>The IP address of the WAN port of the gateway is shown.</p> <p>DHCP: Obtain IP address automatically. DAG1000-4S is regarded as a DHCP client, which sends a broadcast request and looks for a DHCP server from the LAN to answer. Then the first discovered DHCP server automatically assigns an IP address to the DAG1000-4S from a defined range of numbers.</p> <p>Static IP Address: Static IP address is a semi-permanent IP address and remains associated with a single computer over an extended period of time. This differs from a dynamic IP address, which is assigned <i>ad hoc</i> at the start of each session, normally changing from one session to the next.</p> <p>If you choose static IP address, you need to fill in the following information:</p> <ul style="list-style-type: none"> ● IP Address: the IP address of the WAN port of the DAG1000-4S; ● Subnet Mask: the netmask of the router connected the DAG1000-4S; ● Default Gateway: the IP address of the router connected the DAG1000-4S; <p>PPPoE: PPPoE is an acronym for point-to-point protocol over Ethernet, which relies on two widely accepted standards: PPP and Ethernet. PPPoE is a specification for connecting the users on an Ethernet to the Internet through a common broadband medium, such as a single DSL line, wireless device or cable modem. PPPOE IP address refers to IP address assigned through the PPPoE mode.</p> <p>If you choose PPPoE, you need to fill in to fill in the following information:</p> <ul style="list-style-type: none"> ● Username: the account name of PPPoE ● Password: the password of PPPoE ● Server Name: the name of the server where PPPoE is placed
LAN IP address	IP address of the LAN port of the gateway is shown. If network mode is bridge, LAN port won't be displayed.
DNS Server	IP address of DNS server and default gateway information is displayed.
Cloud Register Status	Whether the DAG1000-4S gateway is registered to cloud or not.

System Uptime	The running time of the DAG1000-4S since it is powered on.
NTP Status	Succeed: the DAG1000-4S gateway is sync to NTP server successfully; Failed: the DAG1000-4S gateway fails to be sync to NTP server. Then you should check network connection and the NTP server.
Network Traffic Statics	Total bytes of message received and sent by network port.
Usage of Flash	Detailed usage of Flash memory
Usage of RAM in Linux	Detailed RAM usage of Linux core
Usage of RAM in AOS	Detailed RAM usage of AOS
Current Software Version	The software version that runs on the gateway. Model name, version number and the software development date are displayed.
Backup Software Version	Backup software is for the purpose of backup. When the current software fails, the backup software version will work.
U-boot	U-boot version
Kennel version	Linux Kennel version
FS Version	File system version
Hint Language	The current language of the DAG1000-4S gateway

3.5.2 Registration Information

Port Registration Information					
Port No.	Type	Primary User ID	Primary User Status	Secondary User ID	Secondary User Status
0	FXS	6001	Registered	---	---
1	FXS	6002	Registered	---	---
2	FXS	6003	Registered	---	---
3	FXS	6004	Registered	---	---

Port Group Registration Information					
Port Group	Port	Primary User ID	Primary User Status	Secondary User ID	Secondary User Status
---	---	---	---	---	---

Figure 3.5-2 Port and Port Group Registration Information

Primary/Secondary User status:

- ▶ Registered: the port is registered to SIP server successfully;
- ▶ Unregistered: the port fails to be registered to SIP server.

3.5.3 TCP/UDP Statistics

TCP/UDP Traffic			
TCP Sent Packets	TCP Recv Packets	UDP Sent Packets	UDP Recv Packets
1092	820	567	311

Figure 3.5-3 TCP/UDP Statistics Information

The above interface shows the statistical number of sending or receiving packets over TCP, and the number of sending or receiving packets over UDP since the DAG1000-4S is booted up.

3.5.4 RTP Session Statistics

RTP Session										
Port	Payload Type	Packet Period	Local Port	Peer IP	Peer Port	Sent Packets	Recv Packets	Lost Packets	Jitter	Duration(s)
---	---	---	---	---	---	---	---	---	---	---

Figure 3.5-4 RTP Session Statistics

The above interface shows real-time RTP session information, including: port, payload type, packet period, local port, peer IP, peer port, sent packets, receive packets, lost packets, jitter and duration.

3.5.5 CDR Statistics

CDR (Call Detail Record): is a data record produced by a telephone exchange or a telecommunication device, which contains the details of a telephone call that passes through the device.

CDR Report													
Enable CDR	<input checked="" type="radio"/> No <input type="radio"/> Yes	<input type="button" value="save"/>											
Port	<input type="text" value="All"/>	Source	<input type="text"/>	Destination	<input type="text"/>								
CDR Oper	<input type="button" value="Export"/>	Filter	<input type="button" value="Filter"/>	Clear	<input type="button" value="Clear"/>								
Total: 0Item 50Item/Page 1/1Page <input type="text" value="Page1"/>													
Port	Start Date	Answer Date	Direction	Source	Destination	PeerIP	Codec	Reason	Duration(s)	RTPSend	RTPRecv	RTPLoss	Jitter(s)

On the **Status & Statistic** → **CDR** interface, details of all calls through the ports of the DAG1000-4S are displayed. The CDR function can be enabled on this interface.

3.6 Quick Setup Wizard

Quick setup wizard guides user to configure the device step by step. User only needs to configure network, SIP server and SIP port in the Quick Setup Wizard interface. Basically, after these three steps, user is able to make voice call via the DAG1000-4S device.

3.7 Network Configuration

3.7.1 Local Network

The DAG1000-4S gateway has two kinds of network mode: route and bridge. When the gateway works under the route mode, it will work as a small router and NAT function is enabled. Under this situation, WAN port is normally connected to router/switch or ADSL MODEM, while LAN port is connected local computer or other network device (such as Ethernet switches, Hubs etc.).

When the gateway works under the bridge mode, WAN port and LAN port are the same. The gateway serves as a two-port Ethernet switch. Under this network mode, user only needs to configure the IP address of WAN port and DNS.

DHCP:

Obtain IP address automatically.

Static IP Address:

Static IP address is a permanent IP address which is assigned by Internet Service Provider (ISP) and remains associated with a single computer over an extended period of time. This differs from a dynamic IP address, which is assigned *ad hoc* at the start of each session, normally changing from one session to the next.

PPPoE:

PPPoE is an acronym for point-to-point protocol over Ethernet, which relies on two widely accepted standards: PPP and Ethernet. PPPoE is a specification for connecting the users on an Ethernet to the Internet through a common broadband medium, such as a single DSL line, wireless device or cable modem. All the users over the Ethernet share a common connection, so the Ethernet principles supporting multiple users in a LAN combine with the principles of PPP, which apply to serial connections. PPPOE IP address refers to IP address assigned through the PPPoE mode.

If you choose PPPoE, you need to fill in the account, password and service name, which are provided by telecom operator.

Local Network

IP Protocol IPv4

Network Mode Route Bridge

WAN Port

Obtain an IP address automatically

Use the following IP address

IP Address 172.16.37.57

Subnet Mask 255.255.0.0

Default Gateway 172.16.1.1

PPPoE

Account

Password

Service Name

WAN MTU 1500

LAN Port

IP Address 192.168.11.1

Subnet Mask 255.255.255.0

LAN MTU 1500

DNS Server

Obtain DNS server address automatically

Use the following DNS server address

Primary DNS Server 8.8.8.8

Secondary DNS Server 4.4.4.4

Figure 3.7-1 Route Mode

Local Network

IP Protocol IPv4

Network Mode Route Bridge

Network Configuration

Obtain an IP address automatically

Use the following IP address

IP Address 172.16.37.57

Subnet Mask 255.255.0.0

Default Gateway 172.16.1.1

PPPoE

Account

Password

Service Name

WAN MTU 1500

DNS Server

Obtain DNS server address automatically

Use the following DNS server address

Primary DNS Server 8.8.8.8

Secondary DNS Server 4.4.4.4

Figure 3.7-2 Bridge Mode

【Notes】 :

- If DHCP is selected to obtain IP address, please ensure DHCP server in the network works normally.
- When the gateway works under the route mode, the IP address of LAN port and that of WAN port cannot be at the same network segment, otherwise the gateway can't work normally.
- When the gateway works under the route mode, log in the gateway's web configuration interface via the LAN port.
- After the configurations are finished, please restart the gateway for the configurations to take effect.

3.7.2 VLAN (Virtual Local Area Network)

In order to control the impacts brought by broadcast storms, user can divide VLANs into three groups, namely VLAN1, VLAN2 and VLAN3. There are kinds of VLAN, including data VLAN, voice VLAN and management VLAN. Different kind of VLAN has different messages.

► 802.1Q

The IEEE 802.1Q standard defines the architecture for Virtual Bridged LANs, the services provided in Virtual Bridged LANs and the protocols and algorithms involved in the provision of those services.

No Quality of Service mechanisms are defined in this standard, but an important requirement for providing QoS is included in this standard, e.g. the ability to regenerate user priority of received frames using priority information contained in the frame and the User Priority Regeneration Table for the reception Port.

► 802.1P

IEEE 802.1P standard, describes important methods for providing QoS at MAC level. IEEE 802.1p is in fact quite good. Lower priority level packets are not sent, if there are packets in queued in higher level queues. IEEE 802.1p describes no admission control protocols. It would be possible to give Network Control priority to all packets and the network would be easily congested.

The screenshot shows the 'VLAN' configuration page for 'VLAN 1'. On the left, there are checkboxes for 'Data', 'Voice', and 'Management'. Below these are fields for '802.1Q VLAN1 ID(0 - 4095)' (value: 1) and '802.1P Priority(0 - 7)' (value: 0). Under 'VLAN 1 Network Settings', there are radio buttons for 'Obtain an IP address automatically' (selected) and 'Use the following IP address', with sub-fields for IP Address, Subnet Mask, and Default Gateway. Similarly, there are radio buttons for 'Obtain DNS server address automatically' (selected) and 'Use the following DNS server addresses', with sub-fields for Primary and Secondary DNS Server. At the bottom, there is a 'VLAN1 MTU' field with the value 1400. On the right side, there are checkboxes for 'Enable' and 'Management', and input fields for '1' and '0'.

Figure 3.7-3 VLAN parameter configuration

Explanations of the parameters in VLAN interface:

VLAN1/VLAN2/VLAN3	The gateway supports three VLANs at most. Please enable VLAN according to actual needs.
Data/Voice/Management,	If the checkboxes on the right of data, voice and management of VLAN1 are selected, it means data messages, voice messages and management messages are subject to the network setting, 802.1Q VLAN1 ID and 802.1P Priority of VLAN1.

802.1Q VLAN ID(0-4095)	Set an ID to identify a VLAN based on 802.1Q protocol.
802.1p Priority (0-7)	Set the priority of a VLAN based on 802.1P protocol.
Network Setting	Set a DHCP IP address or static IP address for a VLAN, and set the IP address of the DNS server used by the VLAN.

【Note】 : User needs to restart the gateway for the configurations to take effect.

3.7.3 DHCP Server (Route Mode)

When the gateway works under the route mode, it works as a small router and user can its DHCP service so that the DAG1000-4S serves as a DHCP server in the network.

- ▶ “Start address” and “end address” of the address pool determine the range of IP addresses which are automatically assigned to other devices.
- ▶ “IP Expire Time” means the service time of an assigned IP address. When the service time expires, the IP address will no longer be by the network equipment.
- ▶ The subnet mask, gateway, DNS and other information will be transferred to the network equipment through the DHCP protocol.

DHCP Server Config

DHCP Server	<input checked="" type="checkbox"/> Enable
IP Pool Starting Address	<input type="text" value="192.168.11.100"/>
IP Pool Ending Address	<input type="text" value="192.168.11.199"/>
IP Expire Time	<input type="text" value="72"/> h
Subnet Mask (Optional)	<input type="text" value="255.255.255.0"/>
Default Gateway (Optional)	<input type="text" value="192.168.11.1"/>
Primary DNS Server (Optional)	<input type="text" value="192.168.11.1"/>
Secondary DNS Server (Optional)	<input type="text"/>

Figure 3.7-4 DHCP Server Configuration Interface

【Note】 : When configuring the start IP address, end IP address, subnet mask and gateway IP address, please set them at the same network segment with the IP address of LAN port. Otherwise, other devices under the network will not work normally after they get the IP address assigned by the DHCP server. After the configurations are finished, please restart the DAG1000-4S for the configurations to take effect.

3.7.4 DMZ Host (Route Mode)

If the DMZ service is enabled, the devices in the wide-area network are allowed to have direct access to the devices in the DMZ (demilitarized zone). In this way, devices in the wide-area network can visit the devices which are in the local area network and meanwhile the devices in the local area network are protected.

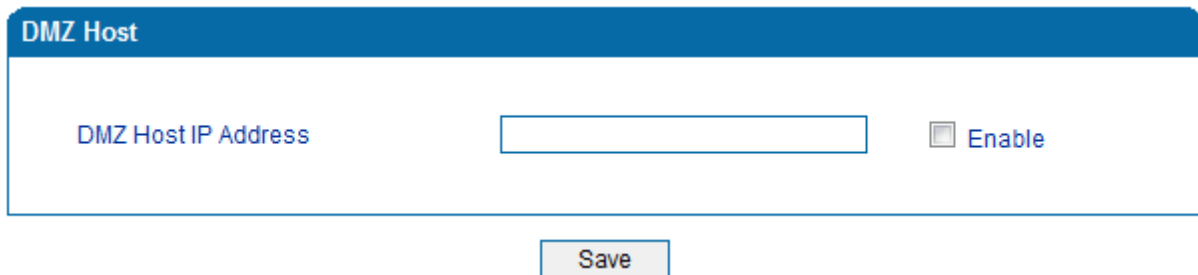

The image shows a configuration interface titled "DMZ Host". It contains a text input field labeled "DMZ Host IP Address" and a checkbox labeled "Enable". Below the input field and checkbox is a "Save" button.

Figure 3.7-5 DMZ Configuration Interface

【Note】 After the configurations are finished, please restart the DAG1000-4S for the configurations to take effect.

3.7.5 Forward Rule (Route Mode)

Sometimes, a device under the LAN network needs to provide a port for communication with the WAN network (such as providing the port 21 for FTP service). In those cases, user can configure forwarding rules for that network device.

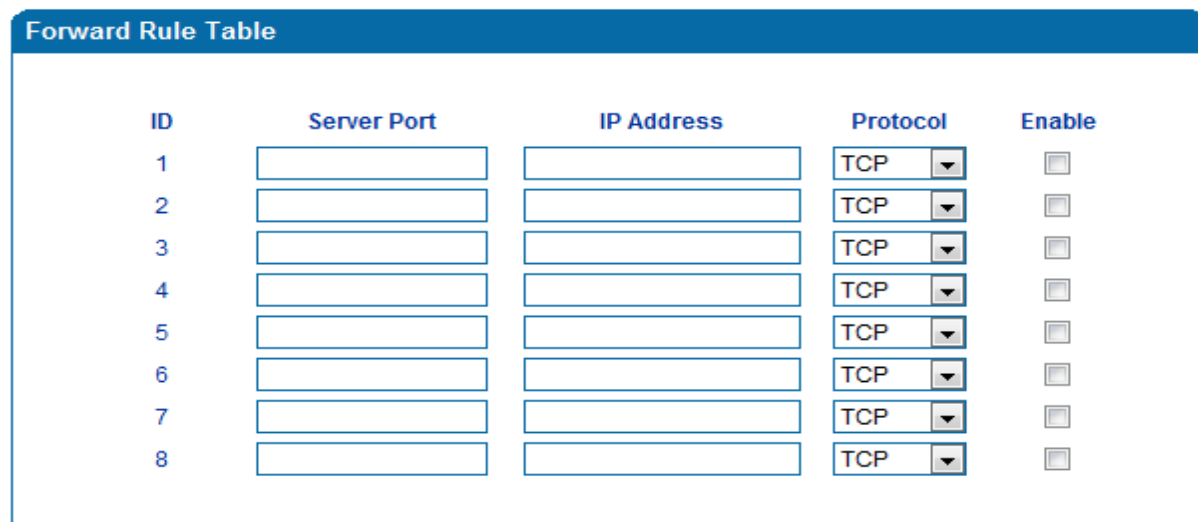

The image shows a configuration interface titled "Forward Rule Table". It contains a table with 5 columns: ID, Server Port, IP Address, Protocol, and Enable. There are 8 rows, each with a text input field for Server Port, a text input field for IP Address, a dropdown menu for Protocol (all set to TCP), and a checkbox for Enable.

ID	Server Port	IP Address	Protocol	Enable
1	<input type="text"/>	<input type="text"/>	TCP	<input type="checkbox"/>
2	<input type="text"/>	<input type="text"/>	TCP	<input type="checkbox"/>
3	<input type="text"/>	<input type="text"/>	TCP	<input type="checkbox"/>
4	<input type="text"/>	<input type="text"/>	TCP	<input type="checkbox"/>
5	<input type="text"/>	<input type="text"/>	TCP	<input type="checkbox"/>
6	<input type="text"/>	<input type="text"/>	TCP	<input type="checkbox"/>
7	<input type="text"/>	<input type="text"/>	TCP	<input type="checkbox"/>
8	<input type="text"/>	<input type="text"/>	TCP	<input type="checkbox"/>

Figure 3.7-6 Configuration Interface for Forwarding Rules

Service port is the port that provides service for the WAN network, while IP address is the IP address of the network device under the LAN network. The protocol is TCP or UDP.

The different between forwarding rule and DMZ host is that DMZ Host offers all ports (0-1024) and protocols for outside telecommunication while forwarding rule only offers a single or several ports and protocols of TCP or UDP.

When both DMZ Host and forwarding rule are configured, the configuration of forwarding rule is prior to that of DMZ Host.

3.7.6 Static Route (Route Mode)

Static route determines the routing rule during the handling of messages by the gateway. Most of time, user does not need to configure static route. Only when there are multiple network segments in the LAN network and these segments need to complete some specific applications, static route needs to be configured.

Static Route Table				
ID	Dest. IP Address	Subnet Mask	Nexthop	Enable
1	<input type="text"/>	<input type="text"/>	<input type="text"/>	<input type="checkbox"/>
2	<input type="text"/>	<input type="text"/>	<input type="text"/>	<input type="checkbox"/>
3	<input type="text"/>	<input type="text"/>	<input type="text"/>	<input type="checkbox"/>
4	<input type="text"/>	<input type="text"/>	<input type="text"/>	<input type="checkbox"/>
5	<input type="text"/>	<input type="text"/>	<input type="text"/>	<input type="checkbox"/>
6	<input type="text"/>	<input type="text"/>	<input type="text"/>	<input type="checkbox"/>
7	<input type="text"/>	<input type="text"/>	<input type="text"/>	<input type="checkbox"/>
8	<input type="text"/>	<input type="text"/>	<input type="text"/>	<input type="checkbox"/>

Figure 3.7-7 Configuration interface for Static Route

3.7.7 ARP

ARP is address resolution protocol. ARP helps user get the MAC address of a device through its IP address. Under TCP/IP network environment, each host is assigned with a 32-bit IP address, but MAC address needs to be known for message transmission in the physical network. ARP is a tool that converts IP address into MAC address.

ARP	
Type	<input checked="" type="radio"/> Static <input type="radio"/> Dynamic
IP Address	MAC Address
--	--
Total: 0 entry <input type="text"/>	

Figure 3.7-9 ARP Parameters

3.8 SIP Server

Introduction of SIP Server:

- 1) SIP server is the main component of VoIP network and is responsible for establishing all the SIP calls. SIP server is also called SIP proxy server or register server. Both IPPBX and softswitch can act as the role of SIP server.
- 2) Usually, SIP server does not participate in media processing. Under SIP network, media always use end-to-end negotiating. Simple SIP server is only responsible for the establishment, maintenance and cleaning of sessions, while relatively-complex SIP server (SIP PBX) not only provides basic calling and conversational support, but also offers rich services such as Presence, Find-me and Music On Hold.
- 3) SIP server based on Linux platform, such as: OpenSER、sipXecx、VoS、Mera etc.
- 4) SIP server based on windows platform, such as :mini SipServer、Brekeke、VoIPswitch etc.
- 5) Carrier-grade soft switch platform, such as Cisco, Huawei, ZTE etc.

SIP Server	
Primary SIP Server	
Primary SIP Server Address	<input type="text" value="ims.telekomsrbija.com"/>
Primary SIP Server Port (Default: 5060)	<input type="text" value="5060"/>
Registration Expires (Default: 1800)	<input type="text" value="3600"/> s
Heartbeat	<input type="checkbox"/> Enable
Secondary SIP Server	
Secondary SIP Server Address	<input type="text"/>
Secondary SIP Server Port (Default: 5060)	<input type="text" value="5060"/>
Registration Expires (Default: 1800)	<input type="text" value="1800"/> s
Heartbeat	<input type="checkbox"/> Enable
Primary Outbound Proxy	
Primary Outbound Proxy Address	<input type="text" value="sbc.ims.telekomsrbija.com"/>
Primary Outbound Proxy Port	<input type="text" value="5060"/>
Secondary Outbound Proxy	
Secondary Outbound Proxy Address	<input type="text"/>
Secondary Outbound Proxy Port	<input type="text" value="5060"/>
Registration	
Retry Interval when Registration failed	<input type="text" value="30"/> s
Registration times per second (0 means unlimited)	<input type="text" value="0"/>
SIP Transport Type	<input type="text" value="UDP"/> ▼
Local SIP Port	
Use Random Port	<input type="checkbox"/> Enable
SIP UDP/TCP Local Port	<input type="text" value="5060"/>
SIP TLS Local Port	<input type="text" value="5061"/>

Figure 3.8-1 Configuration Interface for SIP Server

Explanation for SIP parameters:

Primary SIP Server Address	The IP address or domain name of the primary SIP server. They are provided by VoIP service provider.
Primary SIP Server port	The Service port of the primary SIP server. It is 5060 by default.
Registration Expires	It is used to avoid excessively frequent registrations. When the time that is set expires, terminals will send register request to the primary SIP server. The time is 1800s by default.
Heartbeat	Heartbeat is used to check the connection between terminal and SIP server.
Secondary SIP Server address	The IP address or domain name of the backup SIP server. They are provided by VoIP service provider.
Secondary SIP Server port	Service port of the backup SIP server. It is 5060 by default.
Registration Expires	It is used to avoid excessively frequent registrations. When the time that is set expires, terminals will send register request to the backup SIP server. The time is 1800s by default.
Secondary SIP heartbeat	Heartbeat is used to check the connection between terminal and SIP server.
Outbound Proxy Address	Outbound proxy IP address or domain name provided by VoIP service provider.
Outbound Proxy Port	Default outbound proxy port is 5060.
Retry Interval when Registration failed	The retry interval time after a registration fails. Default: 30s
Registration times per second	The maximum number of registrations in a second. 0 means no limitation for registrations.
SIP Transport Type	The way of SIP-based transmission. It can be UDP, TCP and Auto. Default: UDP.
Use Random Port	The SIP port for providing services for terminal is chosen by random.
SIP Local Port	Default SIP local service port is 5060.

3.9 Port

Port Modify

Port	<input style="width: 80%;" type="text" value="0"/>
Disable Port	<input type="checkbox"/>
Registration	<input checked="" type="checkbox"/> Enable
Primary Display Name	<input style="width: 80%;" type="text"/>
Primary SIP User ID	<input style="width: 80%;" type="text" value="8001"/>
Primary Authenticate ID	<input style="width: 80%;" type="text" value="8001"/>
Primary Authenticate Password	<input style="width: 80%;" type="password" value="....."/>
Secondary Display Name	<input style="width: 80%;" type="text"/>
Secondary SIP User ID	<input style="width: 80%;" type="text"/>
Secondary Authenticate ID	<input style="width: 80%;" type="text"/>
Secondary Authenticate Password	<input style="width: 80%;" type="password"/>
Offhook Auto-Dial	<input style="width: 80%;" type="text"/>
Auto-Dial Delay Time	<input style="width: 80%;" type="text" value="0"/> s
DND(Do Not Disturb)	<input type="checkbox"/> Enable
Caller-ID	<input checked="" type="checkbox"/> Enable
Number for CFU(Call Forwarding Unconditional)	<input style="width: 80%;" type="text"/>
Number for CFB(Call Forwarding Busy)	<input style="width: 80%;" type="text"/>
Number for CFNRy(Call Forwarding No Reply)	<input style="width: 80%;" type="text"/>
Call Waiting	<input type="checkbox"/> Enable
Play Call Waiting Tone	<input type="checkbox"/> Enable

Figure 3.9-1 Port Configuration Interface

Explanations for port parameters:

Port	Port number
Disable port	Whether to disable port temporarily

Registration	Whether to enable registration for the port
Primary /Secondary SIP Display Name	Primary /Secondary SIP account description. It is used to identify the SIP account
Primary /Secondary SIP User ID	User account information provided by VoIP service provider (ITSP). Usually in the form of digit similar to phone number or actually a phone number.
Primary/Secondary SIP Authenticate ID	SIP service subscriber's authenticate ID used for authentication. It can be identical to or different from SIP User ID.
Primary/Secondary Authenticate password	SIP password which registers to soft switch/SIP server
Offhook Auto-dial	An extension or phone number is pre-assigned here so that the number is automatically dialed as soon as user picks up the phone
Auto-dial Delay Time	How long the auto-dial number is prolonged. If it is set as 3s, the auto-dial number is dialed after 3 seconds pass.
DND	Do not disturb, the phone won't receive any calls in case it enabled
Caller ID	Enable or disable caller ID for corresponding port. If it is disabled, the caller ID for the calls through the port won't be displayed.
Number for CFU	Call forward unconditional. All incoming calls will be forwarded to pre-assigned number automatically
Number for CFB	Call forward on busy. If the line is busy, the call will be forwarded to pre-assigned number automatically
Number for CFNRy	Call forward no reply. If the call is not answered, the call will be forwarded to pre-assigned number automatically
Call Waiting	If call waiting is enabled, a special tone is sent if another caller tries to reach you
Play Call Waiting Tone	If call waiting tone is enabled, caller will hear special tone.

3.10 Advanced

3.10.1 FXS/FXO Parameters

FXS parameters include: timeout Call Progress Tone, Timeout for Dialing, Send Polarity Reversal etc.

FXS / FXO	
Timeout for Dialing	<input type="text" value="5"/> s
Timeout for Answer(Outgoing Call)	<input type="text" value="55"/> s
Timeout for Answer(Incoming Call)	<input type="text" value="55"/> s
No RTP Detected	<input type="checkbox"/> Enable
Period without RTP Packet	<input type="text" value="60"/> s
Call Progress Tone	<input type="text" value="User Define"/> ▼
Ring Back Tone	<input type="text" value="425,280,425,630,1500,3500,0,0"/>
Busy Tone	<input type="text" value="425,280,425,630,500,500,0,0"/>
Dial Tone	<input type="text" value="425,280,425,630,200,300,700,800"/>
Auto Gain Control	<input type="checkbox"/> Enable
Line Parameter	
Port	<input type="text" value="Please Select Port"/> ▼
Work Mode	<input type="text" value=""/> ▼
Voice Output Mode	<input checked="" type="radio"/> Telephone <input type="radio"/> Headset
Config Mode(Gain)	<input checked="" type="radio"/> Basic <input type="radio"/> Advanced
Tx Gain	<input type="text" value=""/> ▼
Rx Gain	<input type="text" value=""/> ▼
FXS Parameter	
Send Polarity Reversal	<input type="checkbox"/> Enable
Detect Hook Flash	<input checked="" type="checkbox"/> Enable
Min Time	<input type="text" value="60"/> ms
Max Time	<input type="text" value="400"/> ms
CID Type	<input type="text" value="FSK"/> ▼
Modulation Type	<input type="text" value="BFSK Bel202"/> ▼
Message Type	<input type="text" value="MDMF"/> ▼
Message Format	<input type="text" value="Display Name and CID"/> ▼
Send CID before Ringing	<input type="checkbox"/> Enable
Delay of Sending CID after Ringing	<input type="text" value="500"/> ms
CFNRy Timeout	<input type="text" value="33"/> s
SLIC Setting	<input type="text" value="600 Ohm"/> ▼
REN	<input type="text" value="4"/>
Long Line Support	<input type="checkbox"/> Enable

Figure 3.10-1 Configuration Interface for FXS Parameters

Explanation for FXS parameters:

Timeout for dialing	With the help of dialing timeout, you can limit the time between two digits while users are typing the digits of a number through an extension. If the timeout expires, the gateway will consider the dialing has finished and will try to send message to SIP server. Default value is 4 seconds.
Timeout for answer(Outgoing call)	This parameter determines how long the caller party will wait for answer when making outgoing calls through a phone.
Timeout for answer(Incoming call)	This parameter determines how long the phone rings when there are incoming calls
No RTP Detected	If this parameter is enabled, the situation will be detected when there is no RTP packets received during the set time period.
Period without RTP Packet	The time period when there is no RTP packets received.
Call Process Tone	The signal tone standard after a phone is picked up. Choose national standards from the drop-down box. Default value is the United States.
Auto Gain Control	Whether to enable automatic gain control
Send Polarity Reversal	If polarity reversal is enabled, call tolls will be calculated based on the changes in voltage. If polarity reverse is disabled, you need to set the time for offhook detection and call tolls will be calculated starting from the set time.
Detect Hook flash	If 'Detect Hook Flash' is enabled, you need to set a minimum time and a maximum time. If a phone's hook flash is pressed for a time period greater than the set minimum time but less than the maximum time, the action is considered as a 'hook flash' operation. If a phone's hook flash is pressed for more the set maximum time, the action is considered as 'hang up the phone'.
CID Type	There are two CID types, namely DTMF and FSK.
Message Type	There are two call display types including SDMF and MDMF
Message Format	The call display format in analog phone. It can be "Display Name and CID", "CID only", or "Display Name only"; default value is "Display Name and CID"

Send CID before Ringing	If this parameter is enabled, the gateway send Caller ID to phone before ringing, otherwise the caller ID will be displayed after ringing.
Delay of sending CID after Ringing	The time how long the caller ID will be delayed when the caller ID is set to be displayed after ringing. Default value is 500ms.
CFNRy Timeout	Timeout for 'call forwarding on no answer' service
SLIC Setting	Impedance matched with analog phone.
Long Line Support	Whether to enable 'Long Analog Extension Line'.

3.10.2 Media Parameter

Media parameters mainly include: RTP start port, DTMF parameter, Preferred Vocoder, etc.

Media Parameter

Use Random Port Enable

RTP Start Port

UDP Checksum Validation Enable

DTMF Parameter

DTMF Method

RFC2833 Payload Type Preferred(Incoming Call)

RFC2833 Payload Type

DTMF Gain

DTMF Send Interval ms

Send Flash Event Enable

Send DTMF Tone to Analog When Call in Active Enable

Preferred Vocoder

	Coder Name	Payload Type	Packetization Time(ms)	Rate(kbps)	Silence Suppression
1st	<input style="width: 80px;" type="text" value="G.711A"/>	<input style="width: 80px;" type="text" value="8"/>	<input style="width: 80px;" type="text" value="20"/>	<input style="width: 80px;" type="text" value="64"/>	<input style="width: 80px;" type="text" value="Enable"/>
2nd	<input style="width: 80px;" type="text" value="G.729"/>	<input style="width: 80px;" type="text" value="18"/>	<input style="width: 80px;" type="text" value="20"/>	<input style="width: 80px;" type="text" value="8"/>	<input style="width: 80px;" type="text" value="Enable"/>
3rd	<input style="width: 80px;" type="text"/>	<input style="width: 80px;" type="text"/>	<input style="width: 80px;" type="text"/>	<input style="width: 80px;" type="text"/>	<input style="width: 80px;" type="text"/>
4th	<input style="width: 80px;" type="text"/>	<input style="width: 80px;" type="text"/>	<input style="width: 80px;" type="text"/>	<input style="width: 80px;" type="text"/>	<input style="width: 80px;" type="text"/>
5th	<input style="width: 80px;" type="text"/>	<input style="width: 80px;" type="text"/>	<input style="width: 80px;" type="text"/>	<input style="width: 80px;" type="text"/>	<input style="width: 80px;" type="text"/>
6th	<input style="width: 80px;" type="text"/>	<input style="width: 80px;" type="text"/>	<input style="width: 80px;" type="text"/>	<input style="width: 80px;" type="text"/>	<input style="width: 80px;" type="text"/>
7th	<input style="width: 80px;" type="text"/>	<input style="width: 80px;" type="text"/>	<input style="width: 80px;" type="text"/>	<input style="width: 80px;" type="text"/>	<input style="width: 80px;" type="text"/>
8th	<input style="width: 80px;" type="text"/>	<input style="width: 80px;" type="text"/>	<input style="width: 80px;" type="text"/>	<input style="width: 80px;" type="text"/>	<input style="width: 80px;" type="text"/>

Codecs Preferred

Figure 3.10-2 Configuration Interface for Media Parameters

Explanation of media parameters:

Use Random Port	If this parameter is enabled, the gateway will choose a port by random as the start port for RTP.
RTP Start Port	Default RTP start port is 8000
DTMF Method	Include SINGAL, INBAND and RFC2833
RFC2833 Payload Type	Payload value, default value is 101
DTMF Gain	Default value is 0 DB
DTMF Send Interval	The interval for sending DTMF signal. The default value is 200ms.
Send Flash Event	If this parameter is enabled, the gateway will send flash event to remote terminal, and thus user does need to handle it locally
Coder Name	The gateway supports G729, G711U, G711A and G723. When outgoing calls are made, G.729 will be used.
Payload Type	Each kind of coding has a unique load value, refer to RFC3551.
Packetization Time	The time for voice packaging
Rate	Voice data flow rate; It is defaulted by system.
Silence Suppression	Default value is 'disabled'. If this parameter is enabled, VoIP transmission bandwidth can be saved, and meanwhile network congestion can be avoided.

3.10.3 SIP Parameters

SIP Parameter	
SUBSCRIBE for MWI(Message Waiting Indicator)	<input type="checkbox"/> Enable
MWI Subscription Expires(Default: 3600)	<input type="text" value="3600"/> s
Voicemail User ID	<input type="text"/>
Visual MWI Type	<input type="text" value="NEON"/>
RFC3407 Support	<input type="checkbox"/> Enable
IP-to-IP Call	<input checked="" type="checkbox"/> Enable
URI includes "user=phone"	<input type="checkbox"/> Enable
INVITE with "P-Preferred-Identity" Header (RFC3325)	<input type="checkbox"/> Enable
Only Accept Calls from ACL(SIP Server or IP Trunk)	<input type="checkbox"/> Enable
Anonymous Call	<input type="checkbox"/> Enable
Reject Anonymous Call	<input type="checkbox"/> Enable
# as Ending Dial Key	<input type="checkbox"/> Enable
# Escape	<input type="checkbox"/> Enable
Send # when First Dial Number is ""	<input checked="" type="checkbox"/> Enable
Value of "Refer To" refers to "Contact"	<input type="checkbox"/> Enable
Third Party Do Not Send 18x Response	<input type="checkbox"/> Enable
REFER Delay	<input type="checkbox"/> Enable
Send BYE when Recv REFER Response(Unattended)	<input type="checkbox"/> Enable
Send New REGISTER when Recv 423 Response	<input checked="" type="checkbox"/> Enable
Cseq Start with 1	<input type="checkbox"/> Enable
Forbid Invalid m=line in reINVITE	<input type="checkbox"/> Enable
Call Confirm Tone	<input type="checkbox"/> Enable
RTP Mode in SDP when Call Holding	<input type="text" value="sendonly"/>
Support Call Waiting of Huawei IPPBX	<input type="checkbox"/> Enable
Accept Orphan 200 Ok	<input type="checkbox"/> Enable
Called Number Preferred	<input type="text" value="Request-Line"/>
Caller-ID Preferred	<input type="text" value="From Header"/>
Report SDP Whatever	<input type="checkbox"/> Enable
18x Response Preferred	<input type="text" value="18x Response with SDP"/>
FlashHook Operation Mode	<input type="text" value="Mode three"/>
Wait Dial Time	<input type="text" value="5"/> s
Attended Transfer Trigger	<input type="text" value="Flashhook+4"/>
Domain Query Type	<input type="text" value="A Query"/>
Domain Re-resolution Interval(0 means disable)	<input type="text" value="0"/> min
DNS Cache	<input checked="" type="checkbox"/> Enable

Session Timer(RFC4028)	<input checked="" type="checkbox"/> Enable
Session-Expires	1800 s
Min-SE	1800 s
Session Refresh Method	INVITE
T1	500 ms
T2	4000 ms
T4	5000 ms
Max Timeout	32000 ms
Heartbeat Interval(1 - 3600)	10 s
Heartbeat Timeout(4 - 64*T1)	16 s
Username of OPTION(Heartbeat) for 'SIP Server'	heartbeat
Username of OPTION(Heartbeat) for 'IP Trunk'	heartbeato

Figure 3.10-3 SIP Parameter Configuration Interface

Explanation of SIP parameters:

SUBSCRIBE for MWI (Message Waiting Indicator)	Whether to enable 'voicemail message waiting indicator'; it is realized in the way of NOTIFY
MWI Subscription Expires	MWI subscription expiry time; Default value is 3600s.
Voicemail User ID	The user ID for access to voicemail box
RFC3407 Support	Whether to enable RFC3407 support.
IP-to-IP Call	If this parameter is enabled, user can dial IP address through a phone to call destination gateway.
URI Includes user=phone	If this parameter is enabled, 'user=phone' will be contained in URI. When calls are routed to PSTN network, the called number will be got from user name. Default value is 'not enable'.
INVITE with "P-Preferred-Identity" Header (RFC3325)	If this parameter is enabled, 'P-Preferred-Identity' Header will be added in INVITE message for anonymous call (Support RFC3325).
Only Accept Call from ACL (SIP server or IP Trunk)	If this parameter is enabled, the gateway only accepts incoming call from SIP server only. Default value is 'not enable'.
Anonymous Call	If this parameter is enabled, 'anonymous' will be included in SIP message.

Reject Anonymous Call	If this parameter is enabled, all anonymous calls will be rejected. Default value is 'not disable'.
# as ending Dial Key	'#' is used as the end mark for dialing.
# Escape	If this parameter is enabled, '#' is considered as a digit of the number that is dialed.
Value of "Refer To" refers to "Contact"	If this parameter is enabled, 'contract header' needs to be filled in in the 'refer to' field of a SIP message.
Third Party Do Not Send 18x Response	If this parameter is enabled, the third party will not send 18x response during a attended transfer.
Send BYE when Recv REFER Response (unattended)	If this parameter is enabled, the third party will send BYE to release session after receiving REFER during a blind transfer.
Send New REGISTER when Recv 423 Response	If this parameter is enabled, the value of 'expires' header will be automatically updated and REGISTER will be re-sent after receiving of 423 response.
Implicit Subscribe	If this parameter is enabled, the gateway will accept implicit subscription.
CSeq Start with 1	If this parameter is enabled, the value of CSeq starts with '1'.
Forbid Invalid m=line in reINVITE	If this parameter is enabled, the gateway will prevent 'invalid m=line' from being carried in the SDP of re-INVITE.
RTP Mode in SDP when Call Holding	Use 'sendonly' or 'inactive' as RTP mode during call holding.
Support Call Waiting of Huawei IPPBX	If this parameter is enabled, the gateway will support call waiting of Huawei IPPBX.
Accept Orphan 200 OK	If this parameter is enabled, the gateway will support different 'to-tag 200 OK' in a INVITE session
Domain Query Type	There are two modes: A QUERY and SRV QUERY. Default is 'A QUERY'.
Domain Re-resolution Interval	Default 0: forbidden
DNS cache	If this parameter is enabled, the gateway will cache the DNS query results.
Early Media	Support the receiving of Early Media.

PRACK(RFC3262)	Support reliable transmission of provisional response
PRACK Only for 18x with SDP	Send PRACK only when there's SDP in 18x response
Early Answer	If this parameter is enabled, SDP will be contained in 18x
Session Timer (RFC4028)	Whether to enable 'session timer', default value is 'no'.
Session-Expires	The Session-Expires header field conveys the session interval for a SIP session.
Min-SE	Min-SE header field indicates the minimum value for the session interval.
T1	T1 timer of SIP protocol, default is 500ms
T2	T2 timer of SIP protocol, default is 400ms
T4	T4 timer of SIP protocol, default is 500ms
Max Timeout	The max timeout of sending or receiving, default is 32s
Heartbeat Interval	Default is 10s.
Heartbeat Timeout	Default to 16s
Username of OPTION(Heartbeat) for "SIP Server"	The user ID part of OPTION SIP message in the heartbeat request for SIP server
Username of OPTION(Heartbeat) for "IP TRUNK"	The user ID part of OPTION SIP message in the heartbeat request for IP trunk

Voicemail instructions:

Here takes the DAG1000-4S gateway together with Elastix as the example to introduce how voicemail works in the gateway.

1) After the gateway registers to Elastix server, enable the voicemail function in Elastix for the corresponding extension number and then set password. As below:

Voicemail & Directory

Status

Voicemail Password

Email Address

Pager Email Address

Email Attachment yes no

Play CID yes no

Play Envelope yes no

Delete Voicemail yes no

IMAP Username

IMAP Password

VM Options

VM Context

VmX Locator

Elastix Voicemail Configuration Interface

2) Check feature code in Elastix and change it if necessary. Its default feature code setting is as follows:

Voicemail

Dial Voicemail	<input type="text" value="*98"/>	<input checked="" type="checkbox"/>	<input type="text" value="Enabled"/>
My Voicemail	<input type="text" value="*97"/>	<input checked="" type="checkbox"/>	<input type="text" value="Enabled"/>

Elastix Voicemail Setting

On the Web interface of DAG1000-4S, click **Advanced** → **SIP Parameter** in the navigation tree and then enter voicemail User ID.

SIP Parameter

SUBSCRIBE for MWI(Message Waiting Indicator) Enable

Voicemail User ID

VoiceMail Setting in SIP Parameter

3) Set ringing time in Elastix. Elastix will prompt user to leave a message after the corresponding extension rings 15 seconds (by default). Then the Elastix sever will record the message. Related setting is shown as follows:

Voicemail

Ringtime Default:	<input type="text" value="15"/>
Direct Dial Voicemail Prefix:	<input type="text" value="*"/>
Direct Dial to Voicemail message type:	Unavailable ▾
Optional Voicemail Recording Gain:	<input type="text"/>
Do Not Play "please leave message after tone" to caller	<input type="checkbox"/>

Voicemail Setting

4) Dial *200# on the extension which is connected to DAG1000-4S, then dial voicemail user ID and enter password for authentication. After that, user will hear a voice message.

3.10.4 Fax Parameter

Fax Config

Fax Mode	Adaptive ▾
Include "a=X-fax" Attribute	<input type="checkbox"/> Enable
Include "a=fax" Attribute	<input type="checkbox"/> Enable
Include "a=X-modem" Attribute	<input type="checkbox"/> Enable
Include "a=modem" Attribute	<input type="checkbox"/> Enable
Include "vbd" Parameter	<input checked="" type="checkbox"/> Enable
Include "silenceSupp" Parameter	<input checked="" type="checkbox"/> Enable
ECM	<input type="checkbox"/> Enable
Rate	14400 bps ▾
Tone Detection by	Local ▾
Switch into Fax Mode When Detected CNG or CED	<input type="checkbox"/>

Figure 3.10-4 Configuration Interface for Fax Parameter

Explanation of fax parameters:

Fax Mode	There are four fax modes: T.38, T.30(Pass-through),Modem and Adaptive.
Include "a=X-fax" Attribute	If this parameter is enabled, "a=X-fax" attribute will be carried in SDP
Include "a=fax" Attribute	If this parameter is enabled, "a=fax" attribute will be carried in SDP

Include Attribute	“a=X-modem”	If this parameter is enabled, “a=X-modem” attribute will be carried in SDP
Include Attribute	“a=modem”	If this parameter is enabled, “a=modem” attribute will be carried in SDP
ECM		Whether to enable ‘Error Correction Mode’.
Rate		The rate of sending or receiving fax
Tone Detection by		Fax sound is detected by caller, callee or automatically

3.10.5 Digit Map

The screenshot shows a web-based configuration interface for 'Digit Map'. At the top, there is a blue header with the text 'Digit Map'. Below the header, there is a status message 'Match Failed(When the registration is successful)' and a button labeled 'Send to the server'. The main area is a large text input field containing the text 'any'.

Figure 3.10-5 Digit Map

Digit Map Syntax

Supported objects	Digit	0-9
	T	Timer
	DTMF	A digit, a timer, or one of the symbols of A, B, C, D, #, or *.
Range	[]	One or more DTMF symbols enclosed in the [], but only one DTMF symbol can be selected.

Range	()	One or more expressions enclosed the (), but only one can be selected.
Separator		Separated expressions or DTMF symbols.
Subrange	-	Two digits separated by hyphen (-) which matches any digit between a nd including the two.
Wildcard	x	Matches any digit of 0 to 9
Modifiers	.	Matches 0 or more times of the preceding element
Modifiers	?	Matches 0 or 1 times of the preceding element

Examples:

(13 15 18)xxxxxxxx	Matches the phone numbers with stating digits as 13, 15 or 18 and the left nine digits as any of 0 to 9.
------------------------	--

3.10.6 Feature Codes

Please make reference to 2.7 Description of Feature Codes and the following table.

Inquiry LAN port IP address	Dial*158# to obtain device WAN port IP address
Inquiry WAN port IP address	Dial*159# to obtain device WAN port IP address
Inquiry Phone Number	Dial*114# to obtain port account
Inquiry PortGroup Number	Dial *115# to obtain port group number
Setting IP Mode	*150*0#, means pppmodem, *150*1#, means static IP, *150*2#, means obtain IP address by DHCP, *150*3#, means pppoe.
Network Work Mode	*157*0#, set network work mode to routing mode; *157*1#, set network work mode to bridge mode
Configure IP Address	*152*+IP, set gateway IP address
Network subnet mask configure	*153*+subnet mask, set gateway subnet mask
Network Gateway Configure	*156*+gateway IP, set gateway

Renew DHCP	*193#, set dynamic IP again
Access Web by Wan in Rout Mode	Allow access web through WAN port: *160*1#; don't allow access web through WAN port: *160*0#
Reset Basic Configuration	Dial *165*000000# to restore default username/password and network configuration
Reset Factory Configuration	*166*000000#, reset factory
Restart Device	*111#, restart device
Call holding	During a call, dial*# into call hold. (Recovery the call through hook flash or *#)
Call by IP	Directly dial the end user IP to call
Call Waiting Activate	*51#, enable call waiting function
Call Waiting Deactivate	*50#, forbid call waiting function
Blind Transfer	If the call transfer to 801, first hook flash and then dial the * 87 * 801#
Call Forward Unconditional Activate	*72*+ phone number#, transfer the call from the phone number
Call Forward Unconditional Deactivate	*73#, forbid call forward unconditional
Call Forward Busy Activate	*90*+ forward busy number#
Call Forward Busy Deactivate	*91#, forbid call forward busy
Call Forward No Reply Activate	*92*+ forward no reply number#
Call Forward No Reply Deactivate	*93#, close this function
Do Not Disturb Activate	*78#, enable DND function
Do Not Disturb Deactivate	*79#, close DND function
Dial Voicemail	*200#, visit voice mail box

3.10.7 System Parameter

System parameters include: STUN, NTP, Provision, EB parameter and Telnet.

- 1) STUN: STUN (Simple Traversal of UDP over NATs) is a lightweight protocol that allows applications to discover the presence and types of NATs and firewalls between them and the public Internet. It also provides the ability for applications to determine the IP addresses allocated to them by the NAT. STUN works with many existing NATs, and does not require any special behavior from them. STUN doesn't support TCP connection and H.323.
- 2) NTP: Network Time Protocol (NTP) is a computer time synchronization protocol.
- 3) Provision: provision is used to make the gateway automatically upgrade with the latest firmware stored on an http server an ftp server or a tftp server.

System Parameter	
Hint Language	English
NAT Traversal	Disable
NTP	<input checked="" type="checkbox"/> Enable
Primary NTP Server Address	10.10.3.148
Primary NTP Server Port	123
Secondary NTP Server Address	
Secondary NTP Server Port	123
SYN Interval	3600 s
Time Zone	GMT+1:00 (Paris, Berlin, Rome, Brussels)
Daylight Saving Time	<input type="checkbox"/> Enable
Daily Reboot	<input type="checkbox"/> Enable
Reboot Time	0 : 0
Summary Config	<input type="checkbox"/> Enable
Summary	
WEB Parameter	
WEB Port	80
SSL Port	443
Telnet Parameter	
Telnet Port	23
Remote Management	
Access WEB by WAN	<input checked="" type="checkbox"/> Enable
Access WEB by LAN	<input checked="" type="checkbox"/> Enable
Access Telnet by WAN	<input checked="" type="checkbox"/> Enable
Access Telnet by LAN	<input checked="" type="checkbox"/> Enable

Figure 3.10-7 Configuration Interface for System Parameters

Explanation for related parameters:

Hint Language	IVR language of the gateway
NAT Traversal	User can choose 'Disable', 'STUN', 'static NAT' and 'dynamic NAT'.
NTP	To Enable or disable NTP
Primary NTP server address	The IP address of primary NTP server; default IP address is us.pool.ntp.org.
Primary NTP server port	The service port of primary NTP server; Default port is 123.
Secondary NTP server address	The IP address of secondary NTP server ; Default IP address is 18.145.0.30
Secondary NTP server port	The service port of secondary NTP server; Default port is 123
SYN Interval	The interval to synchronize the time of the DAG1000-4S. Default value is 3600s.
Time Zone	The time zone of the gateway; Default configuration is United States central time, Chicago.
Daylight Saving Time	Enable or disable daylight saving time
Daily Reboot	Whether to enable daily reboot
Reboot time	The time to reboot the gateway daily
WEB Port	The web port of the gateway; Default port is 80
Telnet port	Listening port of telnet service; Default port is 23
Access WEB by WAN	Enable or disable 'Access web service from WAN'
Access WEB by LAN	Enable or disable 'Access web service from LAN'
Access Telnet by WAN	Enable or disable 'telnet service from WAN'
Access Telnet by LAN	Enable or disable 'telnet web service from LAN'

3.10.8 Action URL

Action URL can be used as a means to allow the VoIP platform to learn about the DAG1000's status. It transmits data via GET request over the HTTP protocol. The DAG1000 is an HTTP client. At HTTP server side, GET request must be processed by the VoIP platform. Thus, the purpose is achieved.

Action URL Configuration	
Event	Action URI
Startup	<input type="text"/>
Offhook	<input type="text"/>
Onhook	<input type="text"/>
Incoming Call	<input type="text"/>
Outgoing Call	<input type="text"/>
Call Build	<input type="text"/>
Call Terminate	<input type="text"/>
Register Status	<input type="text"/>
Heartbeat	<input type="text"/>
Heartbeat Interval	<input type="text" value="10"/> s

Figure 3.10-8 Action URL

3.11 Call & Routing

3.11.1 Wildcard Group

Wildcard Group	
Wildcarded IMPU	Associated IMPU
---	---

Figure 3.11-1 Wildcard Group

3.11.2 Port Group

On the **Port Group** interface, user can group several ports together and then set a strategy for port selection of the group. Parameters of port group include registration, primary display name, primary SIP user id, primary authentication ID and password, secondary display name, secondary SIP user id, secondary authentication ID and password, off-hook auto dial, auto dial delay time, port select and so on.

Port Group Add

Index	<input style="width: 90%;" type="text" value="3"/>
Registration	<input checked="" type="checkbox"/> Enable
Description	<input style="width: 95%;" type="text"/>
Primary Display Name	<input style="width: 95%;" type="text"/>
Primary SIP User ID	<input style="width: 95%;" type="text"/>
Primary Authenticate ID	<input style="width: 95%;" type="text"/>
Primary Authenticate Password	<input style="width: 95%;" type="text"/>
Secondary Display Name	<input style="width: 95%;" type="text"/>
Secondary SIP User ID	<input style="width: 95%;" type="text"/>
Secondary Authenticate ID	<input style="width: 95%;" type="text"/>
Secondary Authenticate Password	<input style="width: 95%;" type="text"/>
Offhook Auto-Dial	<input style="width: 95%;" type="text"/>
Auto-Dial Delay Time	<input style="width: 95%;" type="text"/>
Port Select	<input style="width: 90%;" type="text" value="Cyclic Ascending"/>
Pick Up on Group	<input style="width: 90%;" type="text" value="*#"/>
Port	<input type="button" value="Click to Select Ports for this Group"/>

Figure 3.11-2 Configuration Interface for Port group

Explanation of related parameters

Index	The NO. of the port group ; It uniquely identifies a route, range from 0-7
Description	The description of the port group; it is used to identify the port group
Primary/Secondary Display Name	<p>Port group display, which will be used in SIP message, for example:</p> <pre>INVITE sip:bob@biloxi.com SIP/2.0 Via:SIP/2.0/UDPpc33.atlanta.com;branch=z9hG4bK776asdhs Max-Forwards: 70 To: Bob <sip:bob@biloxi.com> From: Alice <sip:alice@atlanta.com>;tag=1928301774</pre> <p>Here Bob and Alice is the display</p>

Primary/Secondary SIP User ID	User account information, provided by VoIP service provider (ITSP). Usually in the form of digit similar to phone number or actually a phone number.
Primary/Secondary Authenticate ID	SIP service subscriber's authentication ID, it can be identical to or different from SIP User ID.
Primary/Secondary Authenticate Password	Password of SIP user ID
Offhook Auto-Dial	To enter offhook auto-dial number
Auto-dial Delay time	How long auto-dialing will be delayed
Port Select	<p>It specifies the policy for selecting a port for ringing in the port group</p> <ul style="list-style-type: none"> • Ascending: the gateway always selects a port from the minimum number. • Cyclic ascending: the gateway always selects a port from a number next to the number selected last time. If the maximum number was selected last time, the next selected number is the minimum number. The sequence moves in cycles like this. • Descending: the gateway always selects a port from the maximum number. • Cyclic descending: the gateway always selects a port from a number next to the number selected last time. If the minimum number was selected last time, the next selected number is the maximum number. The sequence moves in cycles like this. • Group ring: all ports ring at the same time
Pickup UP on group	When one port rings, user can dial '*#' to pick up the call from other ports under the same port group.
Port	Select ports for this port group

3.11.3 IP Trunk

A peer-to-peer VoIP call occurs when two VoIP phones communicate directly over IP network without IP PBXs between them. IP trunk helps establish peer-to-peer call between gateway and VoIP phones. IP trunk will be used in routing configuration.

Figure 3.11-3 IP Trunk Configuration Interface

Explanation of related parameters:

Index	The No. of the IP trunk; from 0 to 127
Description	The description of the IP trunk; It is used to n identify the IP trunk
Remote Address	IP address or domain name of peer device
Remote Port	SIP port of peer device
Heartbeat	Whether to enable the 'Heartbeat' function for the IP trunk. Default value is ' not enable'. If heartbeat is enabled, the gateway will send "OPTION" to peer device.

3.11.4 Routing Parameter

This parameter determines a call is routed before or after manipulation.

Figure 3.11-4 Configuration Interface for Routing Parameter

3.11.5 IP -> Tel Routing

IP->Tel Routing Add

Index	<input style="width: 95%;" type="text" value="127"/>
Description	<input style="width: 95%;" type="text"/>
Calls from	<input type="radio"/> IP Trunk <input style="width: 100px;" type="text" value="Any"/>
	<input checked="" type="radio"/> SIP Server
Caller Prefix	<input style="width: 95%;" type="text"/>
Callee Prefix	<input style="width: 95%;" type="text"/>
Calls to	<input type="radio"/> Port <input style="width: 100px;" type="text" value="0"/>
	<input checked="" type="radio"/> Port Group <input style="width: 100px;" type="text"/>

Figure 3.11-5 Configuration Interface for IP-Tel Routing

Explanation of related parameters:

Index	IP →Routing priority: from 0 to127; 0 is the highest priority.
Description	It is used to identify the IP → routing
Calls from	IP Trunk or SIP Server; ‘any’ means any IP addresses
Caller Prefix	The prefix of the caller number, which helps match routing exactly. its length is less than or equal to the caller number. For example, if caller number is 2001, the caller prefix can be 200 or 2. ‘any’ means the prefix matches any caller number.
Callee Prefix	The prefix of the called number, which helps match routing exactly. Its length is less than or equal to the called number. If the called number is 008675526456659, the called prefix can be 0086755 or 00.,“any” means the prefix matches any called number
Calls to	Which port or port group to which calls are routed

3.11.6 Tel-IP/Tel Routing

Tel->IP/Tel Routing Add

Index	<input style="width: 95%;" type="text" value="127"/>
Description	<input style="width: 95%;" type="text"/>
Calls from	<input checked="" type="radio"/> Port <input style="width: 60%;" type="text" value="0"/>
	<input type="radio"/> Port Group <input style="width: 60%;" type="text"/>
Caller Prefix	<input style="width: 95%;" type="text"/>
Callee Prefix	<input style="width: 95%;" type="text"/>
Calls to	<input type="radio"/> Port <input style="width: 60%;" type="text" value="0"/>
	<input type="radio"/> Port Group <input style="width: 60%;" type="text"/>
	<input type="radio"/> IP Trunk <input style="width: 60%;" type="text"/>
	<input checked="" type="radio"/> SIP Server

Figure 3.11-6 Configuration Interface for Tel-IP/Tel Routing

Explanation of related parameters:

Index	The index of this Tel →IP/Tel routing, from 0 to 127. Each index cannot be used repeatedly. Routing priority: 0 is the highest priority.
Description	It is used to identify the routing
Calls From	Tel →IP calls are from a port or a port group
Caller Prefix	The prefix of the caller number, which helps match routing exactly. its length is less than or equal to the caller number. For example, if caller number is 2001, the caller prefix can be 200 or 2. 'any' means the prefix matches any caller number.
Callee Prefix	The prefix of the called number, which helps match routing exactly. Its length is less than or equal to the called number. If the called number is 008675526456659, the called prefix can be 0086755 or 00., "any" means the prefix matches any called number.
Calls to	Calls are routed to a port, port group, IP trunk or SIP server

3.11.7 IP – IP Routing

IP->IP Routing Add

Index	<input style="width: 95%;" type="text" value="127"/>
Description	<input style="width: 95%;" type="text"/>
Calls from	<input type="radio"/> IP Trunk <input style="width: 80%;" type="text" value="Any"/>
Caller Prefix	<input style="width: 95%;" type="text"/>
Callee Prefix	<input style="width: 95%;" type="text"/>
Calls to	<input type="radio"/> IP Trunk <input style="width: 80%;" type="text"/>

Figure 3.11-7 Configuration Interface for IP->IP Routing

Explanation of related parameters:

Index	The index of this IP →IP routing, from 0 to 127. Each index cannot be used repeatedly. Routing priority: 0 is the highest priority.
Description	It is used to identify the routing
Calls From	Calls are from IP trunk.
Caller Prefix	The prefix of the caller number, which helps match routing exactly. its length is less than or equal to the caller number. For example, if caller number is 2001, the caller prefix can be 200 or 2. 'any' means the prefix matches any caller number.
Callee Prefix	The prefix of the called number, which helps match routing exactly. Its length is less than or equal to the called number. If the called number is 008675526456659, the called prefix can be 0086755 or 00., "any" means the prefix matches any called number.
Calls to	Calls are routed to IP trunk

3.12 Manipulation Configuration

Number manipulation refers to the change of a called number or a caller number during calling process when the called number or the caller number matches the preset rules.

3.12.1 IP -> Tel Callee

IP->Tel Callee Add

Index	<input style="width: 90%;" type="text" value="127"/>
Description	<input style="width: 90%;" type="text"/>
Calls from	<input type="radio"/> IP Trunk <input style="width: 80%;" type="text" value="Any"/>
	<input checked="" type="radio"/> SIP Server
Caller Prefix	<input style="width: 90%;" type="text"/>
Callee Prefix	<input style="width: 90%;" type="text"/>
Calls to	<input checked="" type="radio"/> Port <input style="width: 80%;" type="text" value="0"/>
	<input type="radio"/> Port Group <input style="width: 80%;" type="text"/>
Stripped Digits from Left	<input style="width: 90%;" type="text"/>
Stripped Digits from Right	<input style="width: 90%;" type="text"/>
Prefix to Add	<input style="width: 90%;" type="text"/>
Suffix to Add	<input style="width: 90%;" type="text"/>
Number of Digits to Leave from Right	<input style="width: 90%;" type="text"/>

Figure 3.12-1 Add IP -> IP Callee

Index	The index of this manipulation, from 0 to 127. Each index cannot be used repeatedly. 0 is the highest priority
Description	Name of this IP ->Tel manipulation name
Calls From	Determine the calls come from IP trunk or SIP server
Caller Prefix	Set a prefix for caller number. The prefix's length is less than or equal to that of the caller number, which helps to match routing. If caller number is 2001, the caller prefix can be 200 or 2. "any" means match any caller number.
Callee Prefix	Set a prefix for called number. The prefix's length is less than or equal to called number, which helps to match routing. If called number is 008675526456659, the called prefix can be 0086755 or 00., "any" means match any called number
Calls to	Determine the port or port group to which the call is routed.

Stripped Digits from Left	The number of digits which are lessened from the left of the callee number
Stripped Digits from Right	The number of digits which are lessened from the right of the callee number
Prefix to Add	The prefix added to the callee number after its digits are lessened.
Suffix to Add	The suffix added to the callee number after its digits are lessened.
Number of Digits to Leave from Right	The number of the retained digits which. are counted from the right of the callee number

3.12.2 Tel -> IP/Tel Caller

Tel->IP/Tel Caller Add

Index	<input style="width: 90%;" type="text" value="127"/>
Description	<input style="width: 90%;" type="text"/>
Calls from	<input checked="" type="radio"/> Port <input style="width: 50px;" type="text" value="0"/> <input type="radio"/> Port Group <input style="width: 50px;" type="text"/>
Caller Prefix	<input style="width: 90%;" type="text"/>
Callee Prefix	<input style="width: 90%;" type="text"/>
Calls to	<input type="radio"/> Port <input style="width: 50px;" type="text" value="0"/> <input type="radio"/> Port Group <input style="width: 50px;" type="text"/> <input type="radio"/> IP Trunk <input style="width: 50px;" type="text" value="Any"/> <input checked="" type="radio"/> SIP Server
Stripped Digits from Left	<input style="width: 90%;" type="text"/>
Stripped Digits from Right	<input style="width: 90%;" type="text"/>
Prefix to Add	<input style="width: 90%;" type="text"/>
Suffix to Add	<input style="width: 90%;" type="text"/>
Number of Digits to Leave from Right	<input style="width: 90%;" type="text"/>

Figure 3.12-2 Add Tel -> IP Caller

Configuration parameters are the same with those of 'IP->Tel Callee'.

3.12.3 Tel-IP/Tel Callee

Tel->IP/Tel Callee Add

Index	127 ▼
Description	
Calls from	<input checked="" type="radio"/> Port 0 ▼
	<input type="radio"/> Port Group ▼
Caller Prefix	
Callee Prefix	
Calls to	<input type="radio"/> Port 0 ▼
	<input type="radio"/> Port Group ▼
	<input type="radio"/> IP Trunk Any ▼
	<input checked="" type="radio"/> SIP Server
Stripped Digits from Left	
Stripped Digits from Right	
Prefix to Add	
Suffix to Add	
Number of Digits to Leave from Right	

Figure 3.12-3 Add Tel-IP Callee

Configuration parameters are the same with those of 'Tel->IP Caller'.

3.13 Routing rule examples

3.13.1 Route any calls from any IP to specific port

After enter the Web interface, click **Call & Routing** → **IP-Tel Routing** in the navigation tree on the left, and then click **Add** to create a new routing rule.

IP->Tel Routing Add

Index	127	
Description	any	
Calls from	<input checked="" type="radio"/> IP Trunk Any	<input type="radio"/> SIP Server
Caller Prefix	any	
Callee Prefix	any	
Calls to	<input checked="" type="radio"/> Port 0	<input type="radio"/> Port Group

Save
Reset
Cancel

NOTES:

1. 'any' in 'Callee Prefix' or 'Caller Prefix' means wildcard string.

In the example above, all calls will be routed to port 0 when the routing rule is matched.

3.13.2 Route any calls from any IP to specified port group

► Create port group

Before we can route calls to a port group, create the port group first as below. On the **Call & Routing** → **Port Group**, click **Add** to create a new port group.

Port Group Add

Index	3	
-------	---	--

Select Port for this Group

<input checked="" type="checkbox"/> Port 0(FXS)	<input checked="" type="checkbox"/> Port 1(FXS)	<input checked="" type="checkbox"/> Port 2(FXS)	<input type="checkbox"/> Port 3(FXS)
---	---	---	--------------------------------------

Select All
Select Invert
Clean
Cancel
Ok

Port
Click to Select Ports for this Group

Port 0 to port2 are assigned to port group 7.

►Route any calls to the port group

On the **Call & Routing** → **IP-Tel Routing** interface, click **Add** to create a new routing rule.

IP->Tel Routing Add

Index	<input type="text" value="127"/>
Description	<input type="text" value="any to port group"/>
Calls from	<input checked="" type="radio"/> IP Trunk <input type="text" value="Any"/>
	<input type="radio"/> SIP Server
Caller Prefix	<input type="text" value="any"/>
Callee Prefix	<input type="text" value="any"/>
Calls to	<input type="radio"/> Port <input type="text" value="0"/>
	<input checked="" type="radio"/> Port Group <input type="text" value="7 <port group 1>"/>

NOTES:

1. 'any' in 'Callee Prefix' or 'Caller Prefix' means wildcard string.

As shown above, if the routing rule is matched, calls will be routed to port group 7.

3.13.3 Route any calls from any port to specific SIP IP trunk

Create IP Trunk on the **Call & Routing** → **IP Trunk** interface:

IP Trunk Add

Index	<input type="text" value="127"/>
Description	<input type="text" value="To_Elastix"/>
Remote Address	<input type="text" value="172.16.125.125"/>
Remote Port	<input type="text" value="5060"/>
Heartbeat	<input type="checkbox"/> Enable

After IP Trunk is created, check the following configuration:

IP Trunk					
	Index	Description	Remote Address	Remote Port	Heartbeat
<input type="checkbox"/>	127	To_Elastix	172.16.125.125	5060	Disable

Total: 1 entry Page 1 ▼

As shown above, the IP trunk is created, and the remote end IP address is 172.16.125.125, the SIP port is 5060.

Create Tel -> IP routing rule

On the **Call & Routing** → **Tel-IP Routing** interface, click “Add” to create a new Tel → IP routing rule.

Tel->IP/Tel Routing Add

Index	<input style="width: 90%;" type="text" value="127"/>	
Description	<input style="width: 90%;" type="text" value="Tel to IP trunk"/>	
Calls from	<input checked="" type="radio"/> Port	<input style="width: 80%;" type="text" value="Any"/>
	<input type="radio"/> Port Group	<input style="width: 80%;" type="text" value="7 <port group 1>"/>
Caller Prefix	<input style="width: 90%;" type="text" value="any"/>	
Callee Prefix	<input style="width: 90%;" type="text" value="any"/>	
Calls to	<input type="radio"/> Port	<input style="width: 80%;" type="text" value="0"/>
	<input type="radio"/> Port Group	<input style="width: 80%;" type="text" value="7 <port group 1>"/>
	<input checked="" type="radio"/> IP Trunk	<input style="width: 80%;" type="text" value="127 <To_Elastix>"/>
	<input type="radio"/> SIP Server	

NOTES:

- 'any' in 'Callee Prefix' or 'Caller Prefix' means wildcard string.

All Tel calls from any caller number to any called number will be routed to IP trunk 127.

3.14 Maintenance

3.14.1 TR069

ACS URL (auto-configuration server URL address) is provided by service provider. The ACS URL generally starts with http:// or https://

Username and password are used for ACS authentication.

TR069	<input checked="" type="checkbox"/> Enable
ACS Configuration	
ACS URL	<input type="text"/>
User Name	<input type="text"/>
Password	<input type="text"/>
Periodic Inform	<input checked="" type="checkbox"/> Enable
Periodic Inform Interval	<input type="text" value="30"/> s
Connect Request	
User Name	<input type="text"/>
Password	<input type="text"/>
Port	<input type="text" value="8099"/>

Figure 3.14-1 TR069 Parameters

3.14.2 SNMP (Simple Network Management Protocol)

SNMP Parameters:

- SNMP enable: to disable or enable the SNMP feature
- SNMP version: the DAG1000-4S gateway supports SNMP v1 and v2
- Community: the community name used to read through SNMP protocol
- Source: the IP address of SNMP server

SNMP Parameter

Snmp
 Enable

Snmp Version
v1

Community Configuration

	Community	Source
1st	<input style="width: 95%;" type="text"/>	<input style="width: 95%;" type="text"/>
2nd	<input style="width: 95%;" type="text"/>	<input style="width: 95%;" type="text"/>
3rd	<input style="width: 95%;" type="text"/>	<input style="width: 95%;" type="text"/>

Note: Value of 'Source' is 'default' or IP Address(eg:192.168.1.1)!

Group Configuration

	Group	Community
1st	<input style="width: 95%;" type="text"/>	<input style="width: 95%;" type="text"/>
2nd	<input style="width: 95%;" type="text"/>	<input style="width: 95%;" type="text"/>
3rd	<input style="width: 95%;" type="text"/>	<input style="width: 95%;" type="text"/>

View Configuration

	ViewName	ViewType	ViewSubtree	ViewMask
1st	<input style="width: 95%;" type="text"/>	<input style="width: 95%;" type="text"/>	<input style="width: 95%;" type="text"/>	<input style="width: 95%;" type="text"/>
2nd	<input style="width: 95%;" type="text"/>	<input style="width: 95%;" type="text"/>	<input style="width: 95%;" type="text"/>	<input style="width: 95%;" type="text"/>
3rd	<input style="width: 95%;" type="text"/>	<input style="width: 95%;" type="text"/>	<input style="width: 95%;" type="text"/>	<input style="width: 95%;" type="text"/>

Note: Value style of 'ViewSubtree' is 'x.x.x.x.x'(multi-nodes) or '.x'(one node).

Access Configuration(v1/v2c)

	Group	Read	Write	Notify
1st	<input style="width: 95%;" type="text"/>	<input style="width: 95%;" type="text"/>	<input style="width: 95%;" type="text"/>	<input style="width: 95%;" type="text"/>
2nd	<input style="width: 95%;" type="text"/>	<input style="width: 95%;" type="text"/>	<input style="width: 95%;" type="text"/>	<input style="width: 95%;" type="text"/>
3rd	<input style="width: 95%;" type="text"/>	<input style="width: 95%;" type="text"/>	<input style="width: 95%;" type="text"/>	<input style="width: 95%;" type="text"/>

Note: The value of Read/Write/Notify references to 'ViewName' in View Configuration. Access Configuration is base on Group Configuration and View Configuration.

Trap Configuration

	Trap Type	Trap IP	Trap Port	Trap Community
1st	<input style="width: 95%;" type="text"/>	<input style="width: 95%;" type="text"/>	<input style="width: 95%;" type="text"/>	<input style="width: 95%;" type="text"/>

Figure 3.14-2 SNMP Parameters

User configuration is only available on SNMP v3.

SNMP Version

User Configuration

	User	AuthType	AuthPassword	PrivacyType	PrivacyPassword
1st	<input type="text"/>	<input type="text" value="v3"/>	<input type="text"/>	<input type="text"/>	<input type="text"/>

Notice:The length of AuthPassword and PrivacyPassword are more than 8!

Group configuration

Group: community group name which consist of character string.

Community: let community join the community group which configured above

Group Configuration

	Group	Community
1st	<input type="text" value="grouppublic"/>	<input type="text" value="public"/>
2nd	<input type="text"/>	<input type="text"/>
3rd	<input type="text"/>	<input type="text"/>

Trap configuration

Trap configuration enable to configure Trap server IP and port. This setting available for SNMP v2c and v1.

Trap Configuration

	TrapFlag	TrapIP	TrapPort	TrapCommunity
1st	<input type="text" value="v2c"/>	<input type="text" value="172.16.22.222"/>	<input type="text" value="162"/>	<input type="text" value="public"/>

3.14.3 Syslog

Syslog is a standard for network device data logging. It allows separation of the software that generates messages from the system that stores them and the software that reports and analyzes them. It also provides devices which would otherwise be unable to communicate a means to notify administrators of problems or performance. There are 5 levels of syslog, Including NONE, DEBUG, NOTICE, WARNING and ERROR.

The Signal Log is include following traces which defined in system by default

- SD, hardware debug
- SIP, SIP signaling trace
- STUN, STUN logs
- ECC, detail information of call control module

- *RE, the common communication module for SCP and SIM*
- *SCP, the communication protocol between gateway and cloud server*

The media log is include following traces which defined in system by default

- *RTP, RTP stream info collection*
- *SIM, to output traces between gateway and remote SIM cards*

The System Log is include following traces which mainly used by developer

- *SYS, system log*
- *TIMER, system process*
- *TASK, system task process*
- *CFM, system process*
- *NTP*

The Management Log is include following traces which defined in system by default

- *CLI, command line*
- *TEL,*
- *LOAD, firmware upload*
- *SNMP*
- *WEBS, embedded web server*
- *PROV, provisioning*

Server Syslog:

When the gateway register to SIM Cloud server, the option will be changed to un-configurable and all logs to be storage on server.

Syslog Parameter	
Local Syslog	<input checked="" type="checkbox"/> Enable
Server Address	<input type="text"/>
Server Port	<input type="text" value="514"/>
Syslog Level	<input type="text" value=""/>
Signal Log	<input type="checkbox"/> Enable
Media Log	<input type="checkbox"/> Enable
System Log	<input type="checkbox"/> Enable
Management Log	<input type="checkbox"/> Enable
CDR	<input type="checkbox"/> Enable
Server Syslog	<input type="checkbox"/> Enable

Figure 3.14-3 Syslog Parameter

Enable send CDR, and then send communication information to syslog server.

3.14.4 Provision

Provision is used to make the DAG1000-4S automatically upgrade with the latest firmware stored on an http server an ftp server or a tftp server.

Provision	
URL	<input type="text"/>
Check Interval	<input type="text"/> s
Account	<input type="text"/>
Password	<input type="text"/>
Proxy Domain	<input type="text"/>
Proxy Port	<input type="text"/>
Proxy Account	<input type="text"/>
Proxy Password	<input type="text"/>
Install updates automatically(recommended)	<input type="checkbox"/> Enable

Figure 3.14-4 Provision

URL	Provisioning server URL, support HTTP, TFTP, FTP
Check Interval	The interval to check the changes on the provisioning server
Account	Account for login provisioning server
Password	Account for login provisioning server

3.14.5 Cloud Server

User can register the gateway to cloud server, and then the gateway will be managed by cloud server.

Cloud Server

Server Address

Port

Domain

Join the remote management system **Enable**

Figure 3.14-5 Cloud Server

Explanation of related parameters

Server Address	The IP address or domain of the cloud server
port	The listening port of the cloud server
Password	Password for register with cloud server

3.15 Security

3.15.1 WEB ACL

ACL (Access Control List) for WEB is used to configure IP addresses (users) that are allowed to access the WEB page of the gateway. The IP address list can't be null once ACL is enabled.

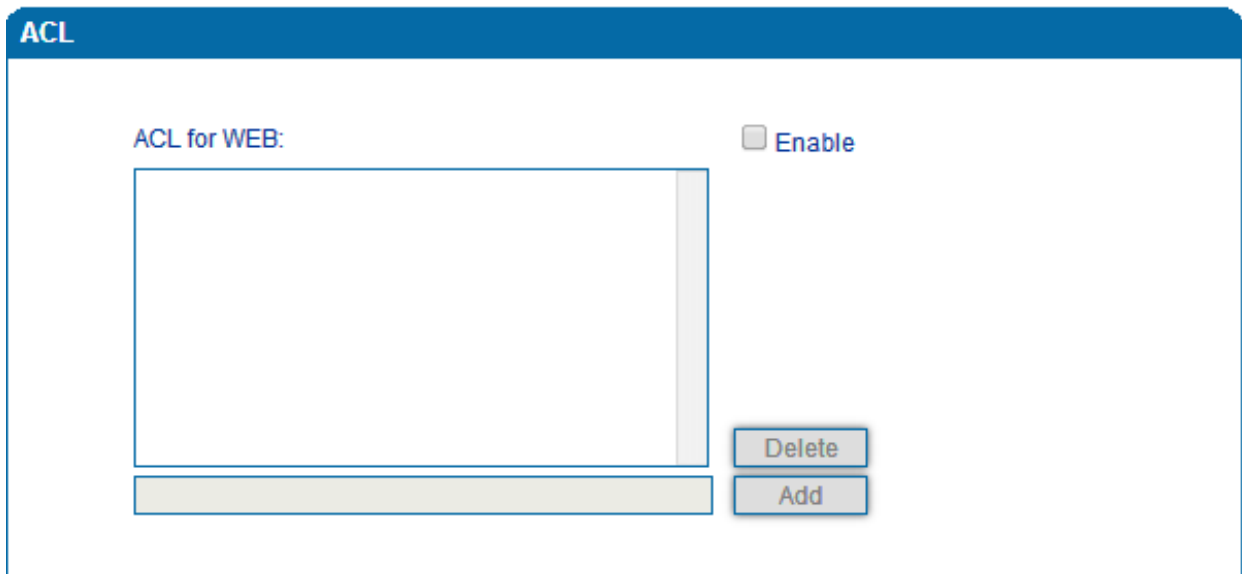

Figure 3.15-1 ACL for WEB

3.15.2 Telnet ACL

ACL (Access Control List) for WEB is used to configure IP addresses (users) that are allowed to access the Telnet page of the gateway. The IP address list can't be null once ACL is enabled.

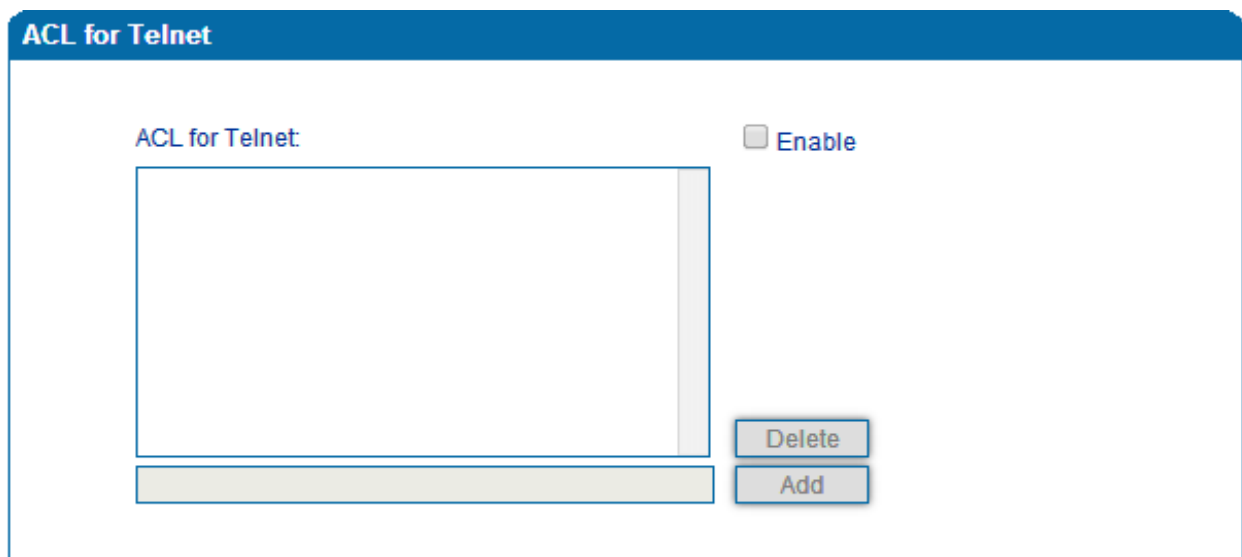

Figure 3.15-2 ACL for Telnet

3.15.3 Passwords

On the following interface user can configure or modify the username and password for access the WEB interface and the Telnet interface.

Note: Both the username and password of Web and Telnet are 'admin' and 'admin'.

Password Modification	
Web Config	
Old Web Username	<input type="text" value="admin"/>
Old Web Password	<input type="text"/>
New Web Username	<input type="text"/>
New Web Password	<input type="text"/>
Confirm Web Password	<input type="text"/>
Telnet Config	
Old Telnet Username	<input type="text" value="admin"/>
Old Telnet Password	<input type="text"/>
New Telnet Username	<input type="text"/>
New Telnet Password	<input type="text"/>
Confirm Telnet Password	<input type="text"/>

Figure 3.15-3 Password Modification

3.16 Tools

3.16.1 Firmware upload

Firmware upload steps:

Step 1.

Check the current firmware version on the **System Information page**

Current Software Version	IAD-4S 1.19.01.10 PCB 4 LOGIC 0 BIOS 1, 2016-02-19 10:06:41
Backup Software Version	IAD-4S 1.19.01.10 PCB 4 LOGIC 0 BIOS 1, 2016-02-19 10:06:41
DSP Version	MIPS_1_7 Nov 30 2015 17:18:14
U-BOOT Version	5
Kernel Version	4
FS Version	3.0.14
Hint Language	English

Figure 3.16-1 Firmware Version

Step 2.

Prepare firmware package. The most important is that the package must match with the existing version. Package version consists of the following parts:

1.18.xx.xx

01/02 is vendor name

18 is hardware version, xx.xx is version number

Step 3.

Upload firmware, select the package from specific folder on the computer and click **Upload** button.

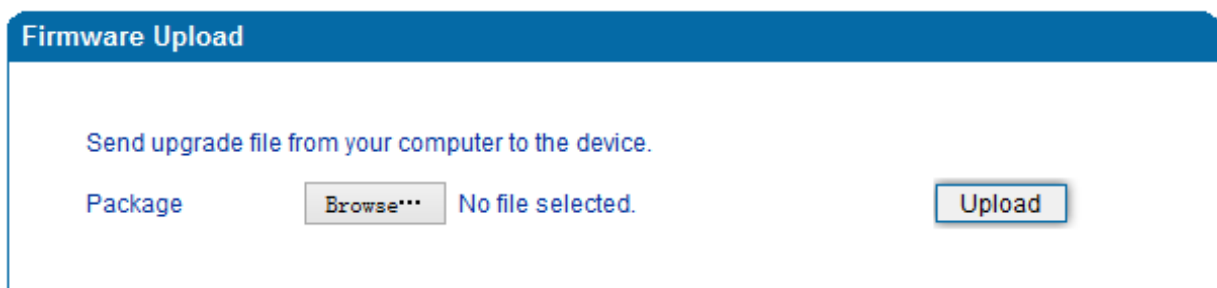

Firmware Upload

Send upgrade file from your computer to the device.

Package No file selected.

Figure 3.16-2 Firmware Upload

Step 4.

Keep waiting until it prompts 'Software loaded successfully!'

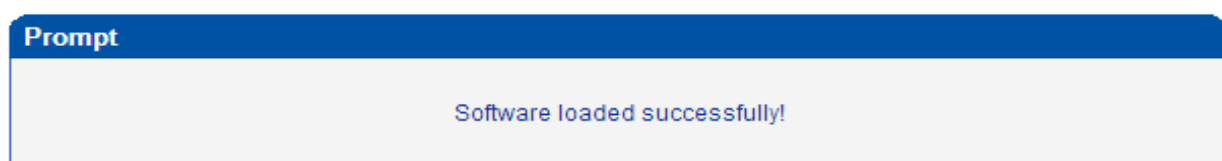

Prompt

Software loaded successfully!

Figure 3.16-3 Successful Firmware Upload

Step 5.

Reboot gateway. Refer to web page **Maintenance-> Device Restart**

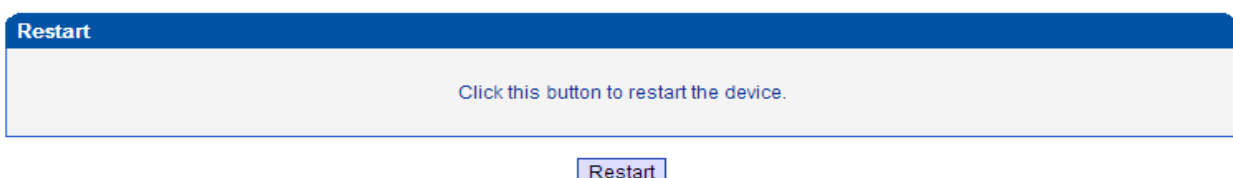

Restart

Click this button to restart the device.

Figure 3.16-4 Restart Gateway

3.16.2 Data Backup

The process data backup:

- 1) Click "Data Backup"
- 2) Click "Backup" to backup data to PC.

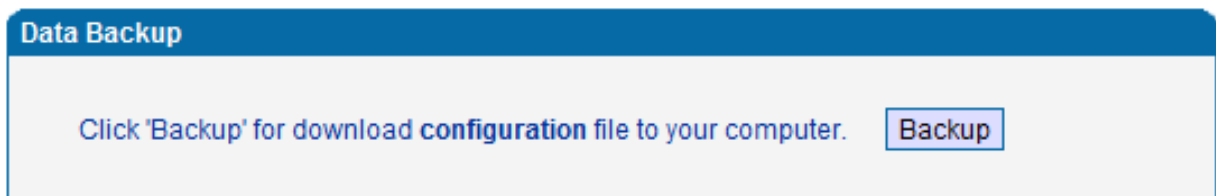

Figure 3.16-5 Data Backup

3.16.3 Data Restore

The processes of data restore:

- ▶ Click 'Data Restore';
- ▶ Browse file, select data file.
- ▶ Click 'Restore' and then import successfully, the device will restart automatically.

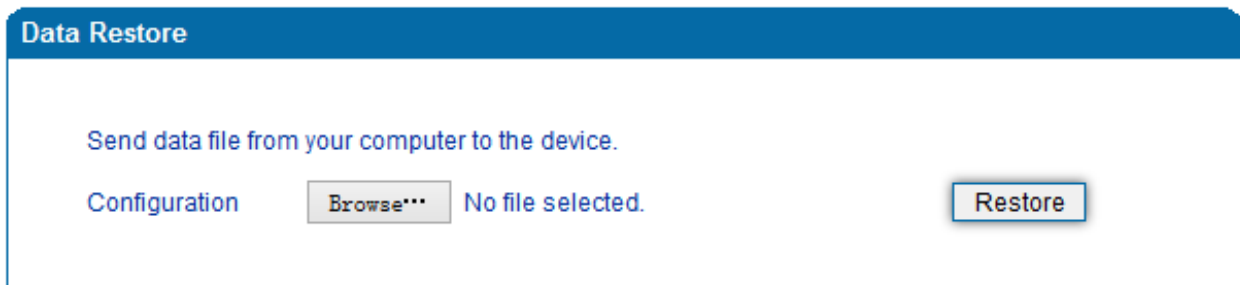

Figure 3.16-6 Data Restore

3.16.4 Ping Test

On the **Tools** → **Ping Test** interface, user can use Ping to check whether the network is working or not.

Ping instructions:

- 1) Click 'Tools → Ping Test' on the navigation tree on the left;
- 2) Fill in IP address or domain whose connection needs to be checked, click **start**.

If a message is received, it indicates that network connection is normal. Otherwise the network connection is faulty.

Ping Test

Destination

Number of Ping(1-100)

Packet Size(56-1024 bytes)

Information

```
Pinging www.google.com[Resolve: 173.194.127.240] with
56 bytes of data:
Reply seq=0 from 173.194.127.240: bytes=56 time=20ms
TTL=54
```

Figure 3.16-7 Ping Test

3.16.5 Tracert Test

Tracert is a trace router used to track routing.

Tracert sends a sequence of Internet Control Message Protocol (ICMP) echo request packets addressed to a destination host. Determining the intermediate routers traversed involves adjusting the time-to-live (TTL), aka hop limit, Internet Protocol parameter. Frequently starting with a value like 128 (Windows) or 64 (Linux), routers decrement this and discard a packet when the TTL value has reached zero, returning the ICMP error message ICMP Time Exceeded.

Tracert works by increasing the TTL value of each successive set of packets sent. The first set of packets sent have a hop limit value of 1, expecting that they are not forwarded by the first router. The next set have a hop limit value of 2, so that the second router will send the error reply. This continues until the destination host receives the packets and returns an ICMP Echo Reply message.

Trace route uses the returned ICMP messages to produce a list of hops (which usually consists of routers and layer 3 switches) that the packets have traversed. The timestamp values returned for each router along the path are the delay (aka latency) values, typically measured in milliseconds for each packet.

Tracert introduce:

- ▶ Click ' Tracert Test' in the navigation tree;
- ▶ Fill in IP address or domain whose route needs to be tracked, and then click **start**.

Tracert Test

Destination

Max Hops(1-255)

Information

```

Tracing route to www.google.com[Resolve:
173.194.127.240] over a maximum of 30 hops:
 0  10 ms  172.16.1.1
 1  1 ms   113.106.38.109
 2  *     Request timed out.
 3  10 ms  121.34.242.234
 4  10 ms  202.97.33.242
 5  10 ms  202.97.60.50
 6  *     Request timed out.
 7  *     Request timed out.
 8  *     Request timed out.
          
```

Figure 3.16-8 Tracert Test

3.16.6 Outward Test

Outward test enable user to diagnose the physical phone lines which follow GR909 standards. To start outward test, select the ports to be tested and click 'start'. Testing costs a few minutes.

Outward Test

Port	Enable	Loop Open	H.F. DC Voltage(V)	H.F. AC Voltage(mV)	Tip/Ring Short	Result
0	<input type="checkbox"/>					
1	<input type="checkbox"/>					
2	<input type="checkbox"/>					
3	<input type="checkbox"/>					
4	<input type="checkbox"/>					
5	<input type="checkbox"/>					
6	<input type="checkbox"/>					
7	<input type="checkbox"/>					

Options:

Test All Ports

Figure 3.16-9 Outward Test

Test results

OK: the analog phone set and phone line are working well

FAIL: analog phone doesn't connect to FXS port or there's something wrong in phone set

3.16.7 Network Capture

Network capture is a very important diagnostic tool for maintenance. It can be used to capture data packages of the available network ports.

Default Setting is PCM capture

PCM capture helps to analysis voice stream between analog phone and DSP chipset.

► To enable PCM capture

- ◆ Select 'PCM' on Network Capture page

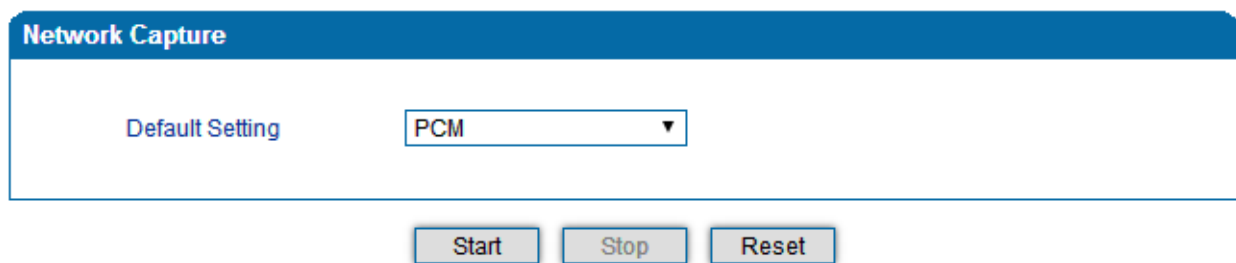

- ◆ Click "Start" to enable PCM capture
- ◆ Dialing out through gateway, start talking a short while then hangup the call.
- ◆ Click 'Stop' to disable network capture
- ◆ Save the capture file to local computer

The capture is named to 'capture(x).pcap', x is serial number of capture and will be added 1 in next time. The sample of PCM capture as below:

No.	Time	Source	Destination	Protocol	Length	Info	
1	0.000000	Motorola_1c:1d:1e	Cimsys_33:44:55	CSM_ENCACS	104	--> 0x0021	Ch: 0xFFFF, Seq: 8 (From Host)
2	0.000131	Cimsys_33:44:55	Motorola_1c:1d:1e	Ethernet	20	Ethernet II[Malformed Packet]	
3	0.000245	Cimsys_33:44:55	Motorola_1c:1d:1e	CSM_ENCACS	44	--> 0x0021	Ch: 0xFFFF, Seq: 11 (From Host)
4	1.320893	Motorola_1c:1d:1e	Cimsys_33:44:55	CSM_ENCACS	104	--> 0x0e00	Ch: 0x0003, Seq: 0 (From Host)
5	1.321022	Cimsys_33:44:55	Motorola_1c:1d:1e	Ethernet	20	Ethernet II[Malformed Packet]	
6	1.321129	Cimsys_33:44:55	Motorola_1c:1d:1e	CSM_ENCACS	30	--> 0x0e00	Ch: 0x0003, Seq: 1 (From Host)
7	1.329890	Motorola_1c:1d:1e	Cimsys_33:44:55	CSM_ENCACS	104	--> 0x0e01	Ch: 0x0003, Seq: 1 (From Host)
8	1.330010	Cimsys_33:44:55	Motorola_1c:1d:1e	Ethernet	20	Ethernet II[Malformed Packet]	
9	1.330093	Cimsys_33:44:55	Motorola_1c:1d:1e	CSM_ENCACS	30	--> 0x0e01	Ch: 0x0003, Seq: 2 (From Host)
10	1.330472	Motorola_1c:1d:1e	Cimsys_33:44:55	CSM_ENCACS	104	--> 0x0802	Ch: 0x0003, Seq: 2 (From Host)
11	1.330566	Cimsys_33:44:55	Motorola_1c:1d:1e	Ethernet	20	Ethernet II[Malformed Packet]	
12	1.330639	Cimsys_33:44:55	Motorola_1c:1d:1e	CSM_ENCACS	30	--> 0x0802	Ch: 0x0003, Seq: 3 (From Host)
13	1.330820	Motorola_1c:1d:1e	Cimsys_33:44:55	CSM_ENCACS	104	--> 0x0803	Ch: 0x0003, Seq: 3 (From Host)
14	1.330903	Cimsys_33:44:55	Motorola_1c:1d:1e	Ethernet	20	Ethernet II[Malformed Packet]	
15	1.330989	Cimsys_33:44:55	Motorola_1c:1d:1e	CSM_ENCACS	30	--> 0x0803	Ch: 0x0003, Seq: 4 (From Host)
16	1.337791	Motorola_1c:1d:1e	Cimsys_33:44:55	CSM_ENCACS	104	--> 0x9010	Ch: 0x0003, Seq: 4 (From Host)
17	1.337906	Cimsys_33:44:55	Motorola_1c:1d:1e	Ethernet	20	Ethernet II[Malformed Packet]	
18	1.338033	Cimsys_33:44:55	Motorola_1c:1d:1e	CSM_ENCACS	30	<-- 0x9010	Ch: 0x0003, Seq: 5 (To Host)
19	1.338369	Motorola_1c:1d:1e	Cimsys_33:44:55	CSM_ENCACS	104	--> 0x9000	Ch: 0x0003, Seq: 5 (From Host)
20	1.338460	Cimsys_33:44:55	Motorola_1c:1d:1e	Ethernet	20	Ethernet II[Malformed Packet]	
21	1.338564	Cimsys_33:44:55	Motorola_1c:1d:1e	CSM_ENCACS	30	<-- 0x9000	Ch: 0x0003, Seq: 6 (To Host)
22	1.343521	Motorola_1c:1d:1e	Cimsys_33:44:55	CSM_ENCACS	104	--> 0x8084	Ch: 0x0003, Seq: 6 (From Host)
23	1.343627	Cimsys_33:44:55	Motorola_1c:1d:1e	Ethernet	20	Ethernet II[Malformed Packet]	
24	1.343725	Cimsys_33:44:55	Motorola_1c:1d:1e	CSM_ENCACS	30	<-- 0x8084	Ch: 0x0003, Seq: 7 (To Host)
25	1.344060	Motorola_1c:1d:1e	Cimsys_33:44:55	CSM_ENCACS	104	--> 0x8001	Ch: 0x0003, Seq: 7 (From Host)

► Getting start to Syslog capture

Syslog capture is another way to obtain syslog which the same as remote syslog server and filelog. The capture file is save as pcap format so that it can be opened in some of capture software like Wireshark, Ethereal software etc.

► To enable syslog capture

- ◆ Select Syslog special only on Network Capture page

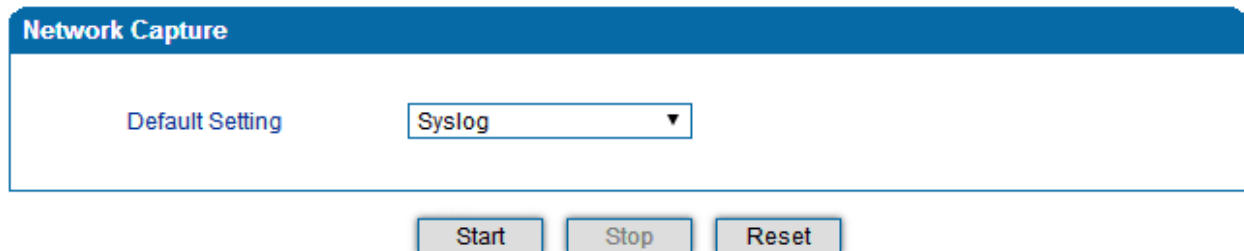

- ◆ Click “Start’ to enable syslog capture
- ◆ Dialing out through gateway, start talking a short while then hangup the call.
- ◆ Click ‘Stop’ to disable syslog capture
- ◆ Save the capture to local computer

The capture is named to ‘capture(x).pcap’, x is serial number of capture and will be added 1 in next time. The sample of syslog capture as below:

No.	Time	Source	Destination	Protocol	Length	Info
1	0.000000	172.16.222.22	1.1.1.1	Syslog	172	USER.DEBUG: Jul 23 06:52:05 172.16.222.22 mpe_sip: < 0> [DEBUG] ----> to 172.16.222.22/5060 crypt:FALSE Phone
2	0.000344	172.16.222.22	1.1.1.1	Syslog	520	USER.DEBUG: Jul 23 06:52:05 172.16.222.22 mpe_sip: < 1> [DEBUG] OPTIONS sip:heartbeat@172.16.222.22 SIP/2.0\r\n
3	0.013432	172.16.222.22	1.1.1.1	Syslog	595	USER.DEBUG: Jul 23 06:52:05 172.16.222.22 mpe_sip: < 2> [DEBUG] <----** message From 172.16.222.22/5060, crypt
4	0.013750	172.16.222.22	1.1.1.1	Syslog	176	USER.DEBUG: Jul 23 06:52:05 172.16.222.22 mpe_sip: < 3> [DEBUG] <---- from 172.16.222.22/5060, crypt:FALSE, Ph
5	0.014036	172.16.222.22	1.1.1.1	Syslog	520	USER.DEBUG: Jul 23 06:52:05 172.16.222.22 mpe_sip: < 4> [DEBUG] OPTIONS sip:heartbeat@172.16.222.22 SIP/2.0\r\n
6	0.014512	172.16.222.22	1.1.1.1	Syslog	172	USER.DEBUG: Jul 23 06:52:05 172.16.222.22 mpe_sip: < 5> [DEBUG] ----> to 172.16.222.22/5060 crypt:FALSE Phone
7	0.014806	172.16.222.22	1.1.1.1	Syslog	587	USER.DEBUG: Jul 23 06:52:05 172.16.222.22 mpe_sip: < 6> [DEBUG] SIP/2.0 200 OK\r\nvia: SIP/2.0/UDP 172.16.222.
8	0.028396	172.16.222.22	1.1.1.1	Syslog	662	USER.DEBUG: Jul 23 06:52:05 172.16.222.22 mpe_sip: < 7> [DEBUG] <----** message From 172.16.222.22/5060, crypt
9	0.028759	172.16.222.22	1.1.1.1	Syslog	176	USER.DEBUG: Jul 23 06:52:05 172.16.222.22 mpe_sip: < 8> [DEBUG] <---- from 172.16.222.22/5060, crypt:FALSE, Ph
10	0.029052	172.16.222.22	1.1.1.1	Syslog	587	USER.DEBUG: Jul 23 06:52:05 172.16.222.22 mpe_sip: < 9> [DEBUG] SIP/2.0 200 OK\r\nvia: SIP/2.0/UDP 172.16.222.
11	0.030017	172.16.222.22	1.1.1.1	Syslog	233	USER.DEBUG: Jul 23 06:52:05 172.16.222.22 mpe_sip: < 10> [DEBUG] sip->app: msgtype:ST_SIP_SERVER_CONN \r\n cal
12	0.331167	172.16.222.22	1.1.1.1	Syslog	983	USER.DEBUG: Jul 23 06:52:05 172.16.222.22 mpe_sip: < 11> [DEBUG] <----** message From 172.16.222.127/5060, cryp
13	0.331498	172.16.222.22	1.1.1.1	Syslog	177	USER.DEBUG: Jul 23 06:52:05 172.16.222.22 mpe_sip: < 12> [DEBUG] <---- from 172.16.222.127/5060, crypt:FALSE, Ph
14	0.331959	172.16.222.22	1.1.1.1	Syslog	907	USER.DEBUG: Jul 23 06:52:05 172.16.222.22 mpe_sip: < 13> [DEBUG] INVITE sip:10086@172.16.222.22:5060 SIP/2.0\r\n
15	0.332307	172.16.222.22	1.1.1.1	Syslog	122	USER.DEBUG: Jul 23 06:52:05 172.16.222.22 mpe_ecc: < 14> [DEBUG] get route entry 31\r\n
16	0.332584	172.16.222.22	1.1.1.1	Syslog	111	USER.DEBUG: Jul 23 06:52:05 172.16.222.22 mpe_ecc: < 15> [DEBUG] }port:3\r\n
17	0.332848	172.16.222.22	1.1.1.1	Syslog	124	USER.DEBUG: Jul 23 06:52:05 172.16.222.22 mpe_ecc: < 16> [DEBUG] get route, to port:3\r\n
18	0.333315	172.16.222.22	1.1.1.1	Syslog	526	USER.DEBUG: Jul 23 06:52:05 172.16.222.22 mpe_sip: < 17> [DEBUG] sip->app: localindex:69, msgtype:SIP_CALL_IN
19	0.333603	172.16.222.22	1.1.1.1	Syslog	173	USER.DEBUG: Jul 23 06:52:05 172.16.222.22 mpe_sip: < 18> [DEBUG] ----> to 172.16.222.127/5060 crypt:FALSE Phone
20	0.333877	172.16.222.22	1.1.1.1	Syslog	386	USER.DEBUG: Jul 23 06:52:05 172.16.222.22 mpe_sip: < 19> [DEBUG] SIP/2.0 100 Trying\r\nvia: SIP/2.0/UDP 172.16.
21	0.346687	172.16.222.22	1.1.1.1	Syslog	131	USER.DEBUG: Jul 23 06:52:05 172.16.222.22 mpe_ecc: < 20> [DEBUG] RTP: alg:0, pkt:20, band:-1\r\n
22	0.347453	172.16.222.22	1.1.1.1	Syslog	120	USER.DEBUG: Jul 23 06:52:05 172.16.222.22 mpe_ecc: < 21> [DEBUG] dial tick:102433\r\n
23	7.232839	172.16.222.22	1.1.1.1	Syslog	533	USER.DEBUG: Jul 23 06:52:12 172.16.222.22 mpe_sip: < 22> [DEBUG] <----** message From 172.16.222.127/5060, cryp
24	7.233513	172.16.222.22	1.1.1.1	Syslog	177	USER.DEBUG: Jul 23 06:52:12 172.16.222.22 mpe_sip: < 23> [DEBUG] <---- from 172.16.222.127/5060, crypt:FALSE, Ph
25	7.233959	172.16.222.22	1.1.1.1	Syslog	457	USER.DEBUG: Jul 23 06:52:12 172.16.222.22 mpe_sip: < 24> [DEBUG] CANCEL sip:10086@172.16.222.22:5060 SIP/2.0\r\n
26	7.234596	172.16.222.22	1.1.1.1	Syslog	287	USER.DEBUG: Jul 23 06:52:12 172.16.222.22 mpe_sip: < 25> [DEBUG] sip->app: localindex:69, msgtype:SIP_CALL_BYE

► Getting start to RTP capture

PCM capture is help to analysis voice stream between gateway and remote IPPBX/SIP Server.

► To enable RTP capture:

- ◆ Select RTP special on Network Capture page

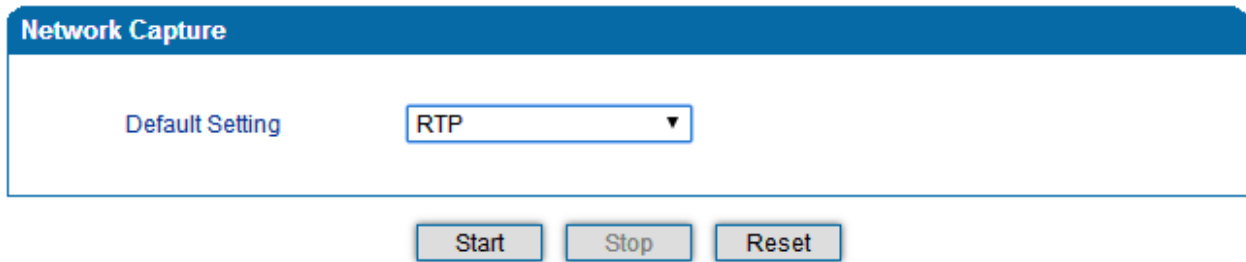

- ◆ Click Start to enable RTP capture
- ◆ Dialing out through gateway, start talking a short while then hangup the call.
- ◆ Click Stop to disable RTP capture
- ◆ Save the capture to local computer

The capture is named to 'capture(x).pcap', x is serial number of capture and will be added 1 in next time. The sample of RTP capture as below:

No.	Time	Source	Destination	Protocol	Length	Info
176	7.020000	172.16.221.228	116.204.105.50	SIP	565	Request: REGISTER sip:116.204.105.50
178	7.030000	116.204.105.50	172.16.221.228	SIP	411	Status: 200 OK (1 bindings)
244	11.610000	172.16.221.228	58.56.64.101	SIP/SDP	814	Request: INVITE sip:201@58.56.64.101
248	11.710000	58.56.64.101	172.16.221.228	SIP	480	Status: 100 Trying
249	11.710000	58.56.64.101	172.16.221.228	SIP/SDP	733	Status: 183 Session Progress
250	11.710000	58.56.64.101	172.16.221.228	SIP/SDP	719	Status: 200 OK
252	11.720000	172.16.221.228	58.56.64.101	RTP	66	Unknown RTP version 1
253	11.720000	172.16.221.228	58.56.64.101	RTP	66	Unknown RTP version 1
254	11.720000	58.56.64.101	172.16.221.228	RTP	74	PT=ITU-T G.729, SSRC=0x497E6D15, Seq=1000, Time=160, Mark
255	11.720000	172.16.221.228	58.56.64.101	RTP	66	Unknown RTP version 1
256	11.730000	172.16.221.228	58.56.64.101	RTP	66	Unknown RTP version 1
257	11.730000	172.16.221.228	58.56.64.101	RTP	66	Unknown RTP version 1
258	11.740000	172.16.221.228	58.56.64.101	SIP	434	Request: ACK sip:201@58.56.64.101:5060
259	11.740000	58.56.64.101	172.16.221.228	RTP	74	PT=ITU-T G.729, SSRC=0x497E6D15, Seq=1001, Time=320
261	11.770000	58.56.64.101	172.16.221.228	RTP	74	PT=ITU-T G.729, SSRC=0x497E6D15, Seq=1002, Time=480
263	11.780000	58.56.64.101	172.16.221.228	RTP	74	PT=ITU-T G.729, SSRC=0x497E6D15, Seq=1003, Time=640
264	11.810000	58.56.64.101	172.16.221.228	RTP	74	PT=ITU-T G.729, SSRC=0x497E6D15, Seq=1004, Time=800
265	11.830000	58.56.64.101	172.16.221.228	RTP	74	PT=ITU-T G.729, SSRC=0x497E6D15, Seq=1005, Time=960
266	11.840000	58.56.64.101	172.16.221.228	RTP	74	PT=ITU-T G.729, SSRC=0x497E6D15, Seq=1006, Time=1120
267	11.870000	58.56.64.101	172.16.221.228	RTP	74	PT=ITU-T G.729, SSRC=0x497E6D15, Seq=1007, Time=1280
268	11.890000	58.56.64.101	172.16.221.228	RTP	74	PT=ITU-T G.729, SSRC=0x497E6D15, Seq=1008, Time=1440
270	11.900000	58.56.64.101	172.16.221.228	RTP	74	PT=ITU-T G.729, SSRC=0x497E6D15, Seq=1009, Time=1600
271	11.930000	172.16.221.228	58.56.64.101	RTP	74	PT=ITU-T G.729, SSRC=0x43455AA6, Seq=31521, Time=1806312883
273	11.930000	58.56.64.101	172.16.221.228	RTP	74	PT=ITU-T G.729, SSRC=0x497E6D15, Seq=1010, Time=1760
274	11.940000	58.56.64.101	172.16.221.228	RTP	74	PT=ITU-T G.729, SSRC=0x497E6D15, Seq=1011, Time=1920
275	11.950000	172.16.221.228	58.56.64.101	RTP	74	PT=ITU-T G.729, SSRC=0x43455AA6, Seq=31522, Time=1806313043
277	11.970000	58.56.64.101	172.16.221.228	RTP	74	PT=ITU-T G.729, SSRC=0x497E6D15, Seq=1012, Time=2080
278	11.970000	172.16.221.228	58.56.64.101	RTP	74	PT=ITU-T G.729, SSRC=0x43455AA6, Seq=31523, Time=1806313203

▶ Getting start to DSP capture

DSP capture is help to analysis voice stream inside DSP chipset. The DSP chipset will handle RTP from IP network as well as voice stream from analog phone.

▶ To enable DSP capture:

- ◆ Select DSP only on Network Capture page

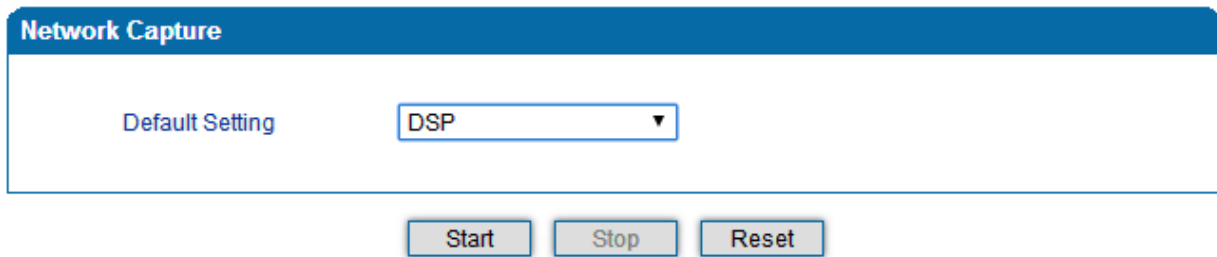

- ◆ Click Start to enable DSP capture
- ◆ Dialing out through gateway, start talking a short while then hangup the call.
- ◆ Click Stop to disable DSP capture
- ◆ Save the capture to local computer

The capture is named to 'capture(x).pcap', x is serial number of capture and will be added 1 in next time. The sample of RTP capture as below:

No.	Time	Source	Destination	Protocol	Length	Info
1	0.000000	Motorola_1c:1d:1e	Cimsys_33:44:55	CSM_ENCACS	104	--> 0x0021 Ch: 0xFFFF, Seq: 2 (From Host)
2	0.007246	Cimsys_33:44:55	Motorola_1c:1d:1e	Ethernet	20	Ethernet II[Malformed Packet]
3	0.007260	Cimsys_33:44:55	Motorola_1c:1d:1e	CSM_ENCACS	44	--> 0x0021 Ch: 0xFFFF, Seq: 5 (From Host)
4	2.994581	Motorola_1c:1d:1e	Cimsys_33:44:55	CSM_ENCACS	104	--> 0x0021 Ch: 0xFFFF, Seq: 3 (From Host)
5	2.997308	Cimsys_33:44:55	Motorola_1c:1d:1e	Ethernet	20	Ethernet II[Malformed Packet]
6	2.997316	Cimsys_33:44:55	Motorola_1c:1d:1e	CSM_ENCACS	44	--> 0x0021 Ch: 0xFFFF, Seq: 6 (From Host)
7	5.992790	Motorola_1c:1d:1e	Cimsys_33:44:55	CSM_ENCACS	104	--> 0x0021 Ch: 0xFFFF, Seq: 4 (From Host)
8	5.997282	Cimsys_33:44:55	Motorola_1c:1d:1e	Ethernet	20	Ethernet II[Malformed Packet]
9	5.997290	Cimsys_33:44:55	Motorola_1c:1d:1e	CSM_ENCACS	44	--> 0x0021 Ch: 0xFFFF, Seq: 7 (From Host)
10	7.691428	Motorola_1c:1d:1e	Cimsys_33:44:55	CSM_ENCACS	104	--> 0x9010 Ch: 0x0003, Seq: 3 (From Host)
11	7.691552	Cimsys_33:44:55	Motorola_1c:1d:1e	Ethernet	20	Ethernet II[Malformed Packet]
12	7.691715	Cimsys_33:44:55	Motorola_1c:1d:1e	CSM_ENCACS	30	--> 0x9010 Ch: 0x0003, Seq: 1 (To Host)
13	7.701379	Motorola_1c:1d:1e	Cimsys_33:44:55	CSM_ENCACS	104	--> 0x9000 Ch: 0x0003, Seq: 4 (From Host)
14	7.701494	Cimsys_33:44:55	Motorola_1c:1d:1e	Ethernet	20	Ethernet II[Malformed Packet]
15	7.701622	Cimsys_33:44:55	Motorola_1c:1d:1e	CSM_ENCACS	30	--> 0x9000 Ch: 0x0003, Seq: 2 (To Host)
16	7.709662	Motorola_1c:1d:1e	Cimsys_33:44:55	CSM_ENCACS	104	--> 0x8084 Ch: 0x0003, Seq: 5 (From Host)
17	7.709798	Cimsys_33:44:55	Motorola_1c:1d:1e	Ethernet	20	Ethernet II[Malformed Packet]
18	7.709902	Cimsys_33:44:55	Motorola_1c:1d:1e	CSM_ENCACS	30	--> 0x8084 Ch: 0x0003, Seq: 3 (To Host)
19	7.710238	Motorola_1c:1d:1e	Cimsys_33:44:55	CSM_ENCACS	104	--> 0x8001 Ch: 0x0003, Seq: 6 (From Host)
20	7.710328	Cimsys_33:44:55	Motorola_1c:1d:1e	Ethernet	20	Ethernet II[Malformed Packet]
21	7.710496	Cimsys_33:44:55	Motorola_1c:1d:1e	CSM_ENCACS	30	--> 0x8001 Ch: 0x0003, Seq: 4 (To Host)
22	7.716241	Motorola_1c:1d:1e	Cimsys_33:44:55	CSM_ENCACS	104	--> 0x8018 Ch: 0x0003, Seq: 7 (From Host)
23	7.716352	Cimsys_33:44:55	Motorola_1c:1d:1e	Ethernet	20	Ethernet II[Malformed Packet]
24	7.716465	Cimsys_33:44:55	Motorola_1c:1d:1e	CSM_ENCACS	30	--> 0x8018 Ch: 0x0003, Seq: 5 (To Host)
25	7.716711	Motorola_1c:1d:1e	Cimsys_33:44:55	CSM_ENCACS	104	--> 0x805b Ch: 0x0003, Seq: 8 (From Host)

► Configurable capture options

► Getting start to custom capture

This menu provides more options to capture specific packets according to actually needs.

Network Capture

Default Setting	<input type="text" value="Custom"/>
Include ARP Packet	<input type="checkbox"/>
Select Port	<input type="text" value="None"/>
Protocol(s)	<input type="checkbox"/> TCP <input type="checkbox"/> UDP <input type="checkbox"/> RTP <input type="checkbox"/> ICMP

3.16.8 Factory Reset

Click 'Apply' to restore the factory settings.

Factory Reset

Click the button below to reset to factory default settings.

Factory Reset

3.16.9 Device Restart

After saving all the configurations or changes to the equipment, user can restart the DAG1000-4S gateway for the changes to take effect.

Restart

Click the button below to restart the device.

Restart Gateway

4 Glossary

- DNS: Domain Name System
- SIP: Session Initiation Protocol
- TCP: Transmission Control Protocol
- UDP: User Datagram Protocol
- RTP: Real Time Protocol
- PPPOE: point-to-point protocol over Ethernet
- VLAN: Virtual Local Area Network
- ARP: Address Resolution Protocol
- CID: Caller Identity
- DND: Do NOT Disturb
- DTMF: Dual Tone Multi Frequency
- NTP: Network Time Protocol
- DMZ: Demilitarized Zone
- STUN: Simple Traversal of UDP over NAT
- PSTN: Public Switched Telephone Network
- IMS: IP Multimedia Subsystem
- ACL: access rule list
- SNMP: Simple Network Management Protocol
- FXS: Foreign Exchange Station
- FXO: Foreign Exchange Office